



BELGARD®
PAVES THE WAY™

T-BLOCK



**WOOD SQUARE
PLANTER**

T-BLOCK

COMPLETE THIS STEP
FIRST FOR ALL PROJECTS

BASE PREPARATION

Always level ground before installation

ON NEW OR EXISTING PATIO

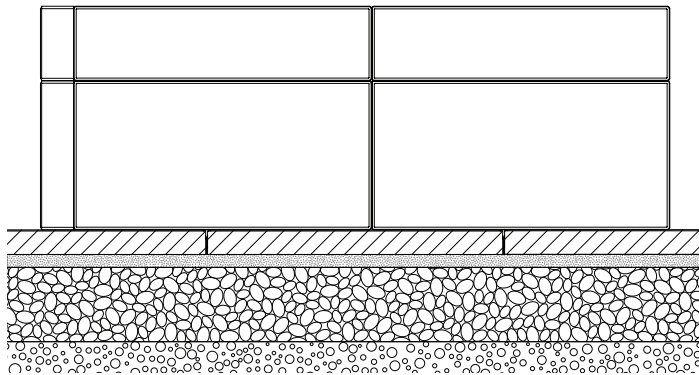

SLAB OR PAVER

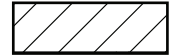

BEDDING SAND 1"

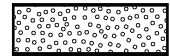

COMPACTED AGGREGATES 6"-8"



SOIL

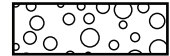

ON POURED CONCRETE

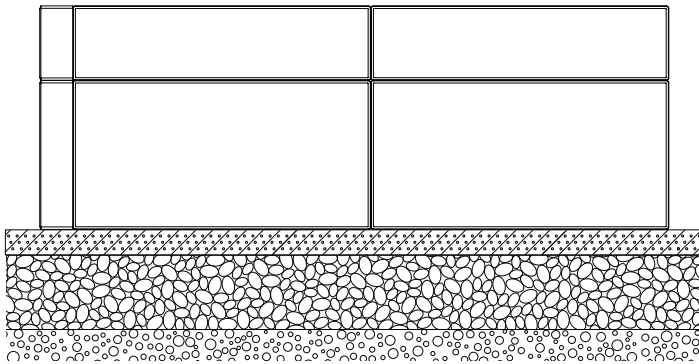

REINFORCED POURED CONCRETE
FOUNDATION 2"

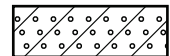

COMPACTED AGGREGATES 6"-8"



SOIL



ON COMPACTED FOUNDATION

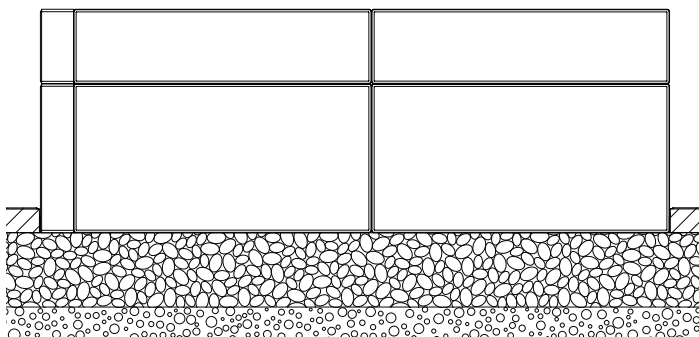

SLAB OR PAVER



COMPACTED AGGREGATES 6"-8"



SOIL

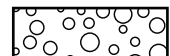

T-BLOCK

WOOD SQUARE PLANTER

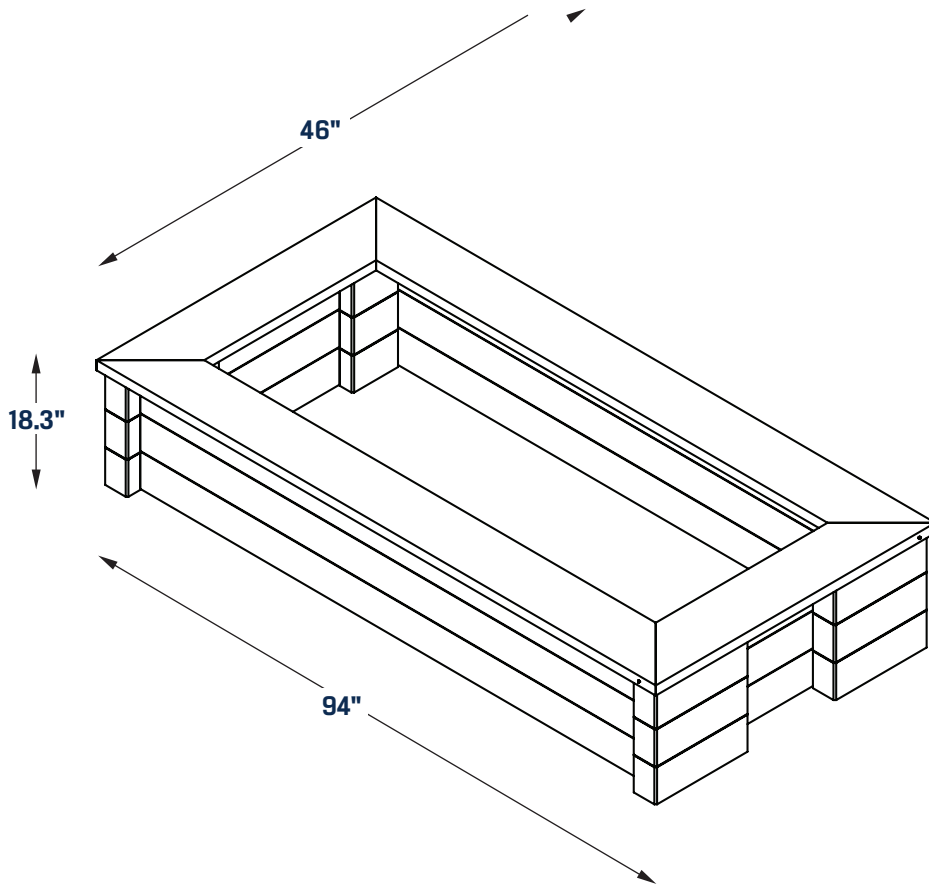

COMPONENTS

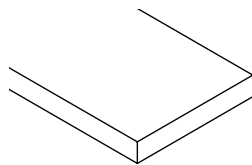

2" x 10" x 8' (x3)

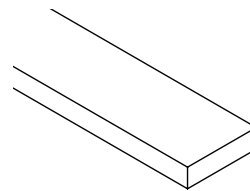

2" x 6" x 8' (x8)

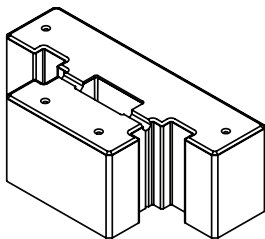

T-Block (x12)



No.8 x 3" (x4)



Glue Tube

T-BLOCK

WOOD SQUARE PLANTER

REQUIRED TOOLS

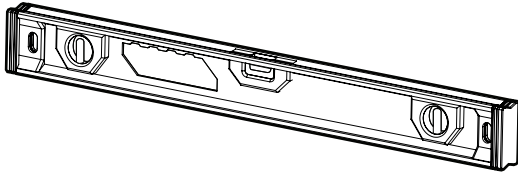

LEVEL

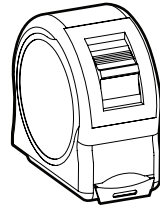

**MEASURING
TAPE**

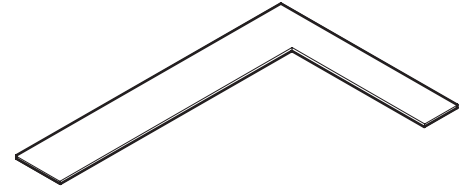

**CARPENTER
SQUARE**

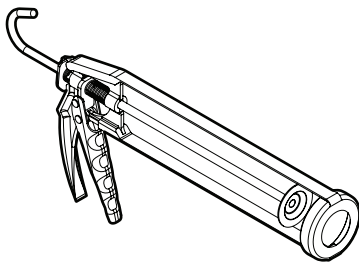

**SILICONE
GUN**

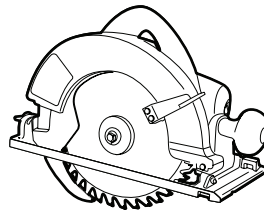

SKILSAW

SAFETY EQUIPMENT



SAFETY BOOTS

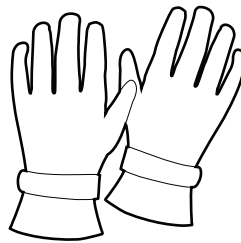

GLOVES

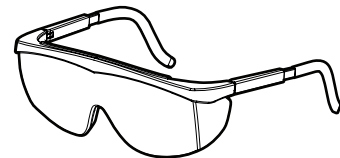

SAFETY GLASSES

T-BLOCK

WOOD SQUARE PLANTER

WOOD CUTS

□ 2" x 6" x 8'

A = $23\frac{3}{8}$ "

■ 2" x 10" x 8'

B = $39\frac{3}{8}$ "

C = $47\frac{1}{2}$ "

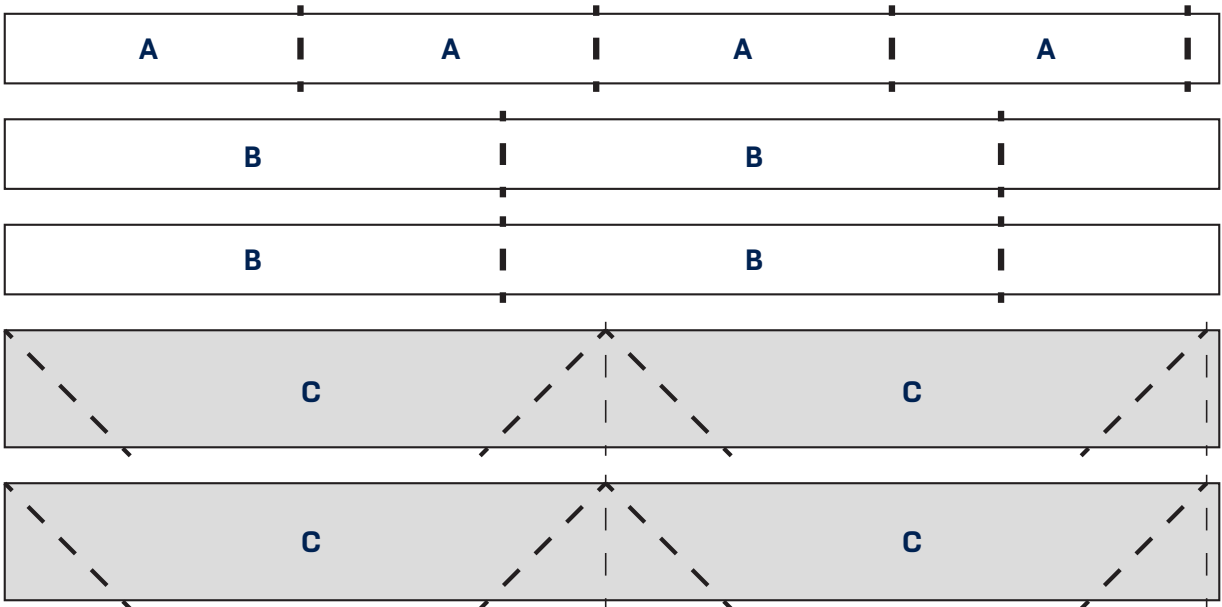
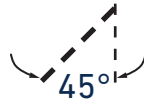

①

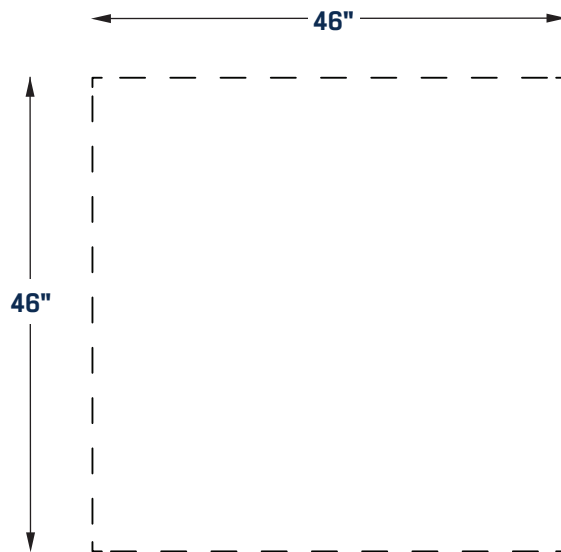

T-BLOCK

WOOD SQUARE PLANTER

2

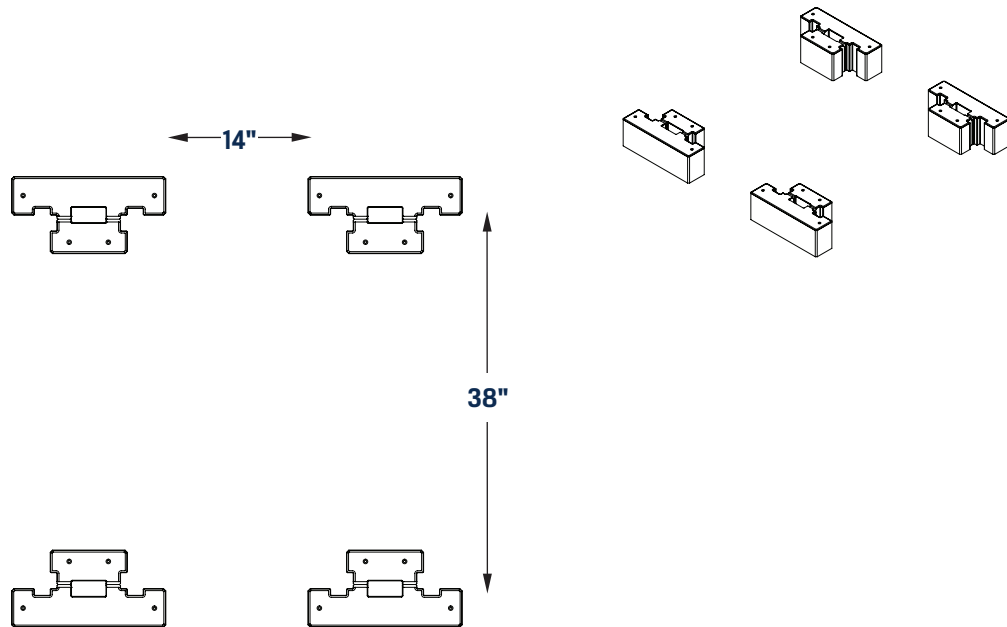

3

Make sure all frame pieces are level. Apply glue in the cavities of the block before laying the next level.

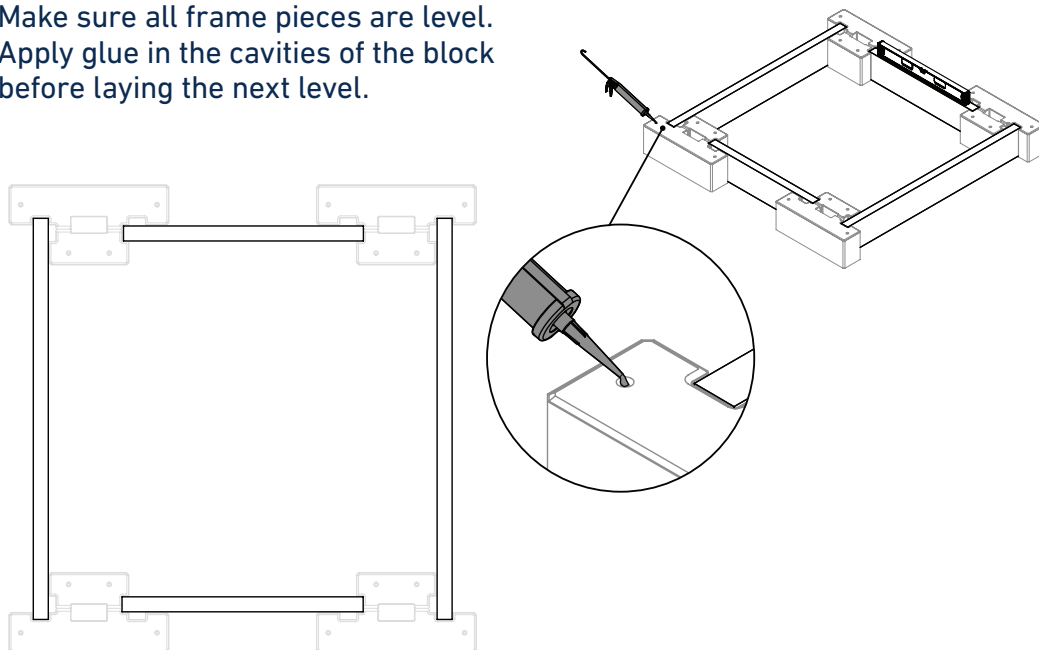

T-BLOCK

WOOD SQUARE PLANTER

- 4 Lay down next level, ensuring they sit flush into place.

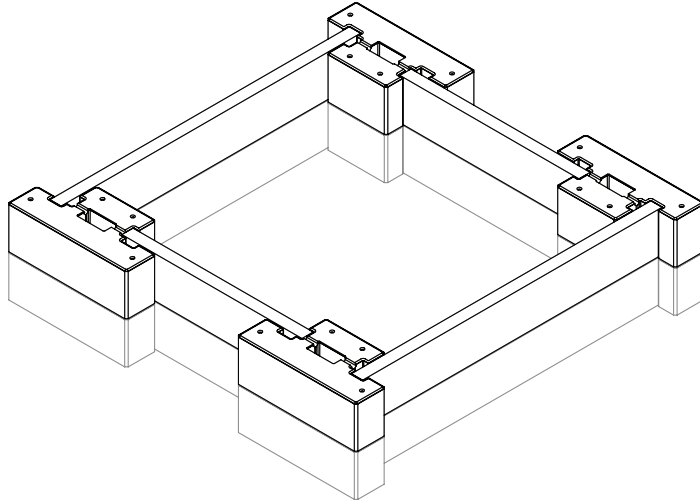

5

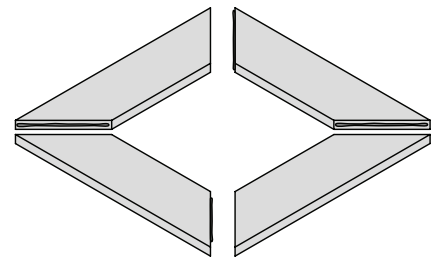
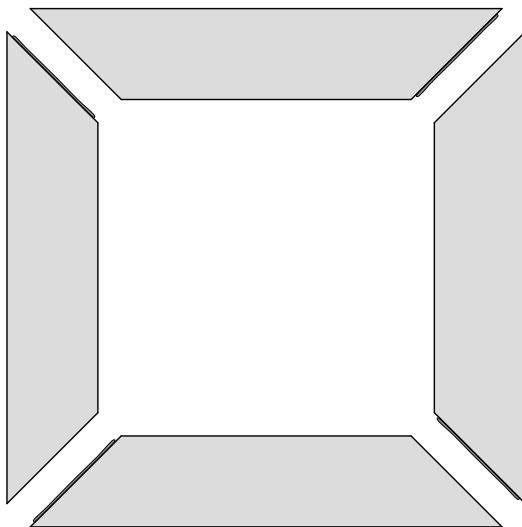

Put the angle pieces together to create the frame shape, keeping all edges aligned while the glue sets.

T-BLOCK

WOOD SQUARE PLANTER

- 6 Add the screws in each corner, making sure they go through the middle of the boards for a solid connection.

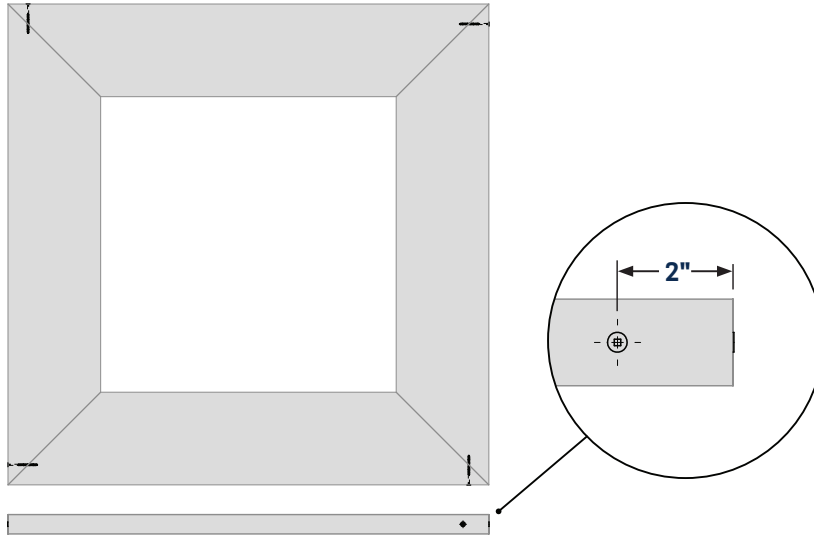

- 7 Apply glue along the top edges of the panels and in the block cavities before setting the frame in place.

