



BELGARD®  
PAVES THE WAY™

# T-BLOCK



**WOOD BENCH  
- 2" x 4" LUMBER**

# T-BLOCK

COMPLETE THIS STEP  
FIRST FOR ALL PROJECTS

## BASE PREPARATION

Always level ground before installation

### ON NEW OR EXISTING PATIO

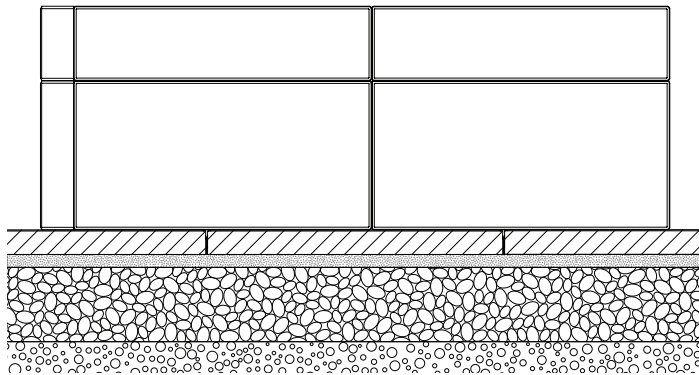

SLAB OR PAVER

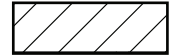

BEDDING SAND 1"

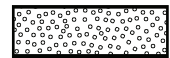

COMPACTED AGGREGATES 6"-8"



SOIL

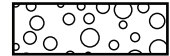

### ON POURED CONCRETE

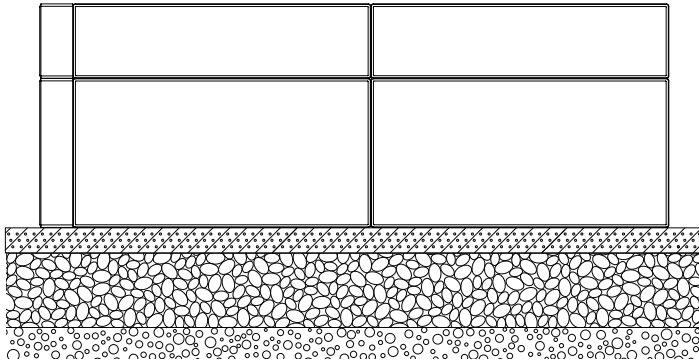

REINFORCED POURED CONCRETE  
FOUNDATION 2"

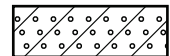

COMPACTED AGGREGATES 6"-8"



SOIL



### ON COMPACTED FOUNDATION

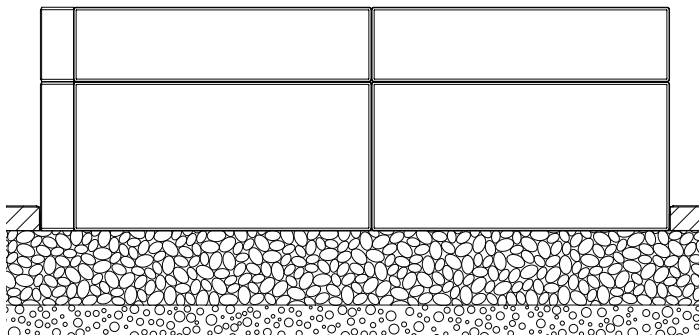

SLAB OR PAVER



COMPACTED AGGREGATES 6"-8"



SOIL

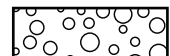

# T-BLOCK

WOOD BENCH  
- 2" x 4" LUMBER

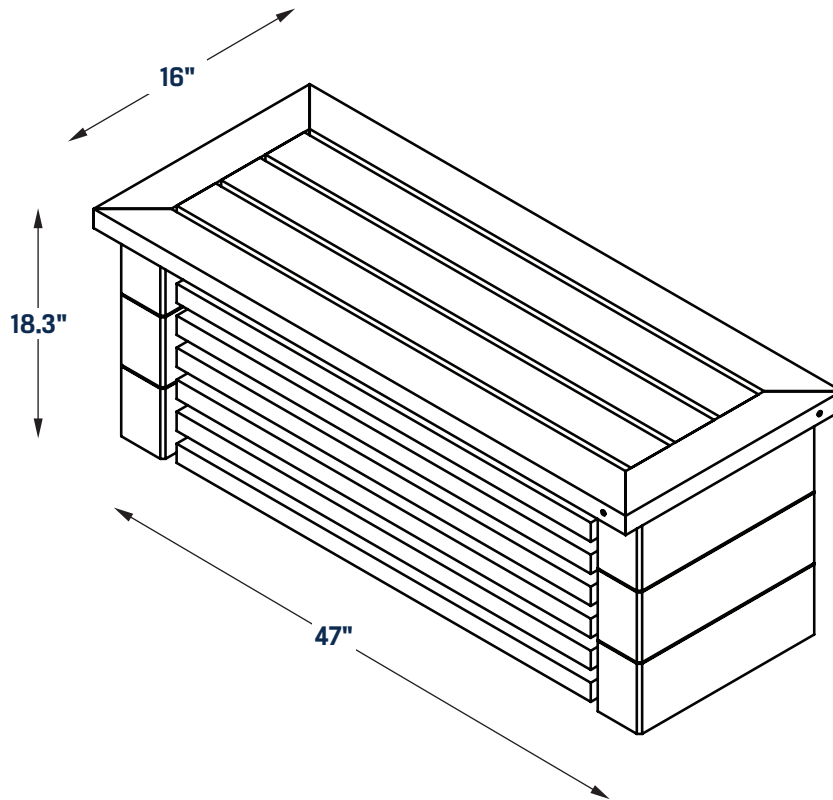

## COMPONENTS

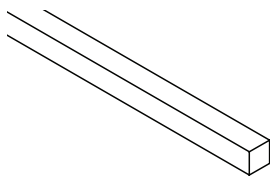

2" x 2" x 8' (x2)

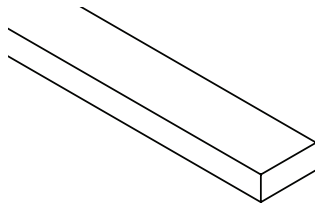

2" x 4" x 8' (x10)

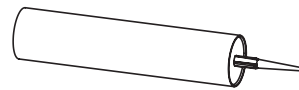

Glue Tube

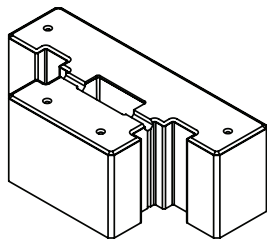

T-Block (x6)



No.8 x 3" (x35)



No.8 x 2 1/2" (x14)



No.8 x 3 1/2" (x6)

# T-BLOCK

**WOOD BENCH  
- 2" x 4" LUMBER**

## REQUIRED TOOLS

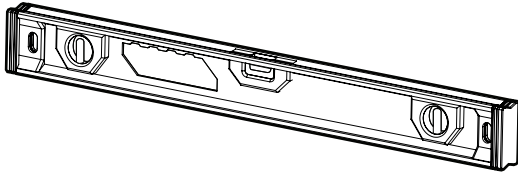

**LEVEL**

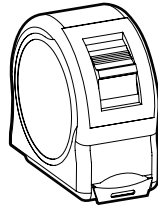

**MEASURING  
TAPE**

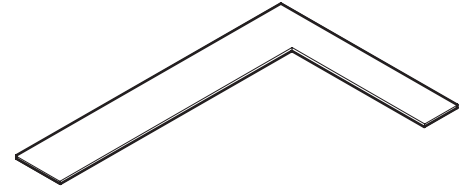

**CARPENTER  
SQUARE**

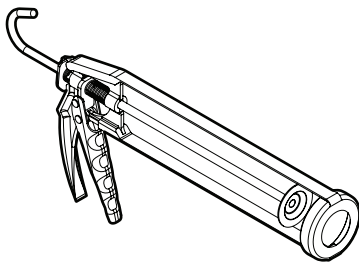

**SILICONE  
GUN**

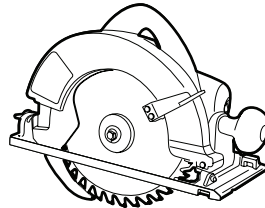

**SKILSAW**

## SAFETY EQUIPMENT



**SAFETY BOOTS**

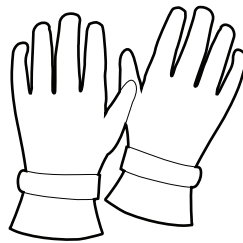

**GLOVES**

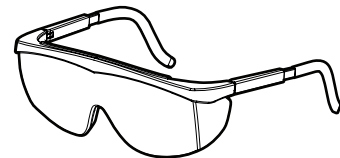

**SAFETY GLASSES**

# T-BLOCK

WOOD BENCH  
- 2" x 4" LUMBER

## WOOD CUTS

□ 2" x 2" x 8'

■ 2" x 4" x 8'

A = 16½"

B = 37¼"

C = 8"

D = 41"

E = 19½"

F = 48"

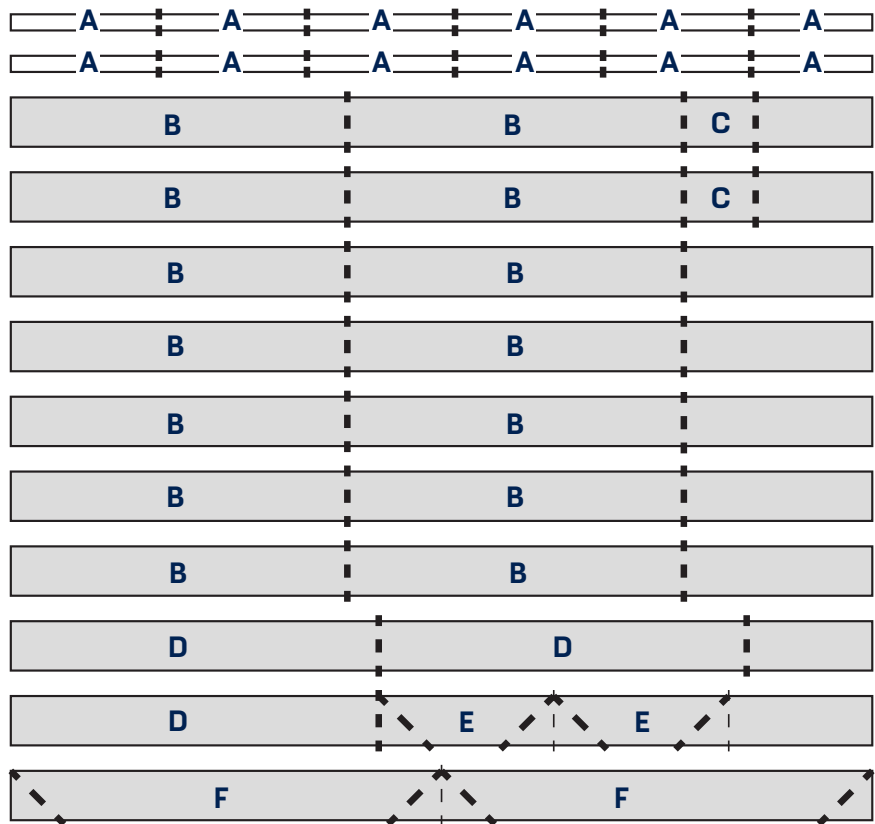

①

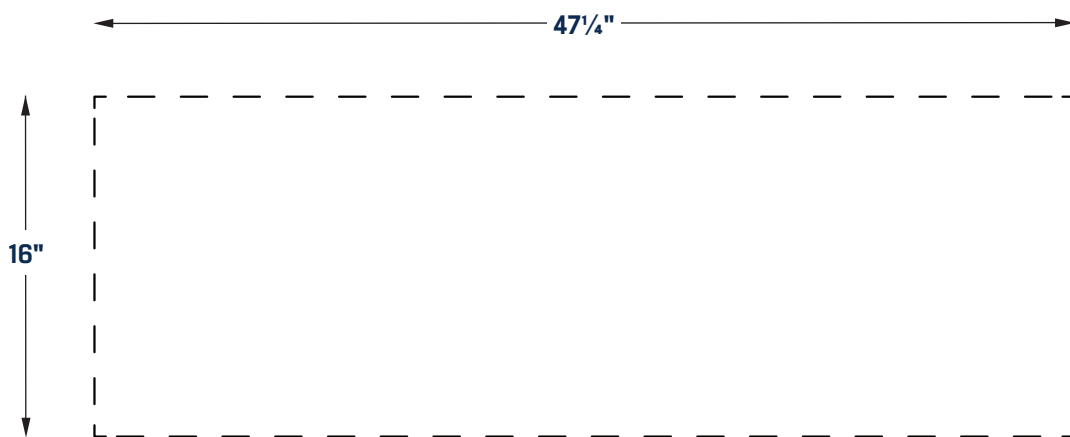

# T-BLOCK

WOOD BENCH  
- 2" x 4" LUMBER

2

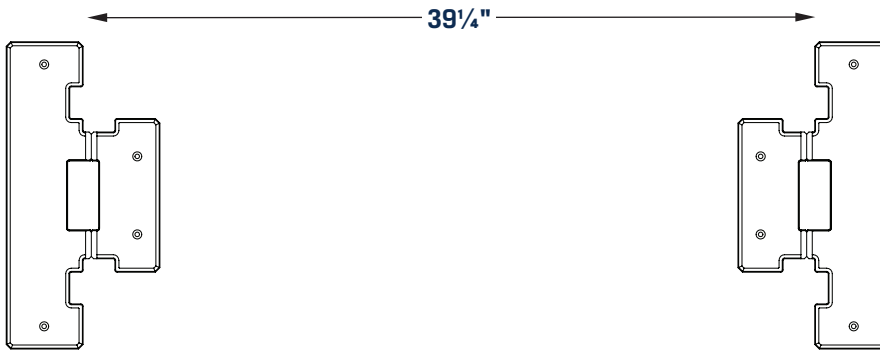
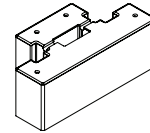
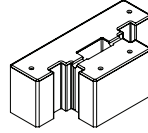

3 Add screws (3") every 2 1/2" to secure the pieces in place on both sides (2x).

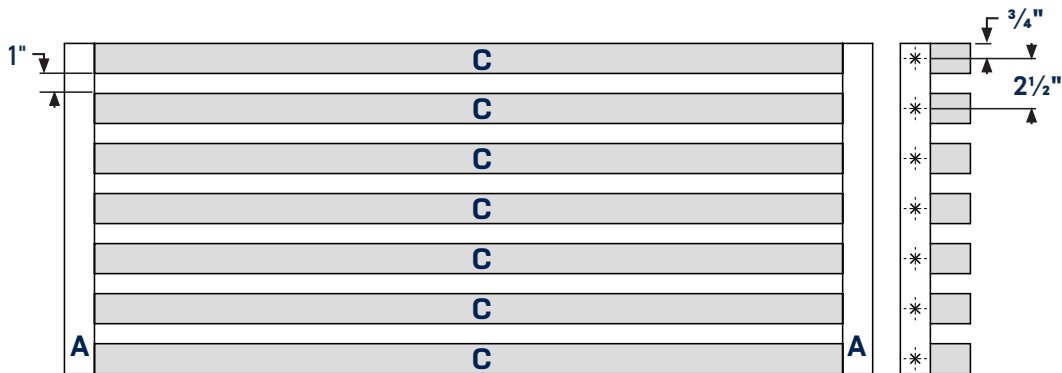
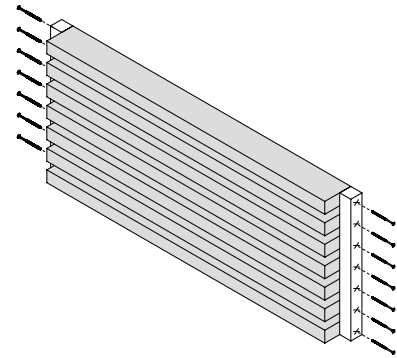

# T-BLOCK

## WOOD BENCH - 2" x 4" LUMBER

- 4 Add screws (3") every 2½" to secure the pieces in place on both sides (2x).

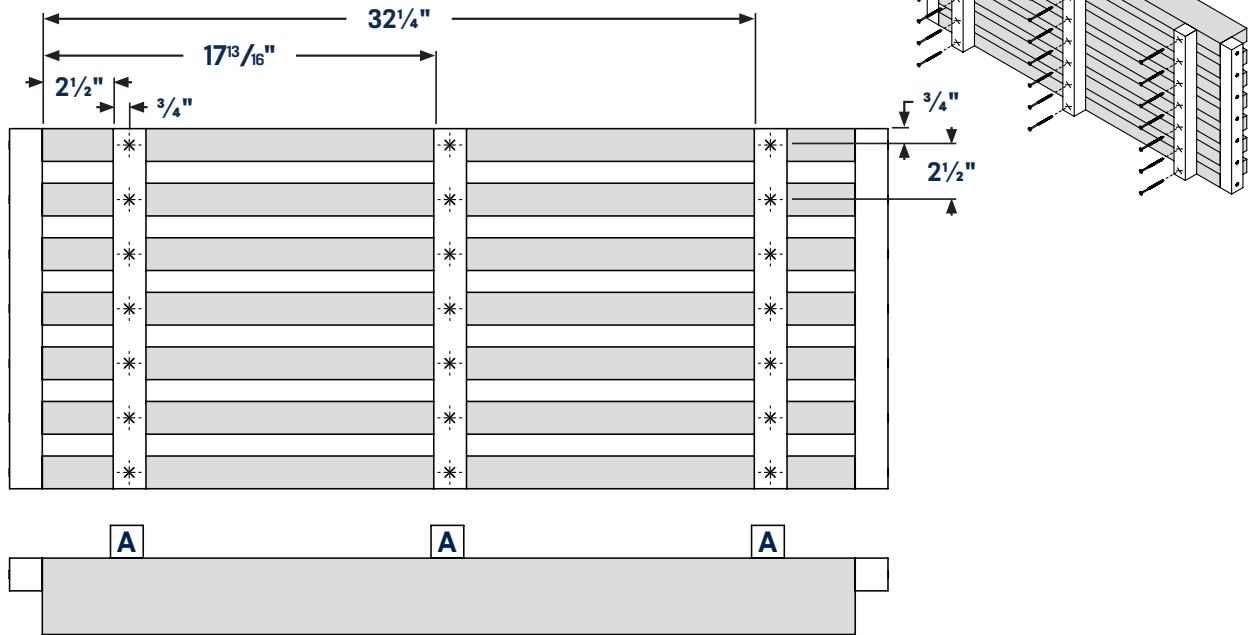

- 5

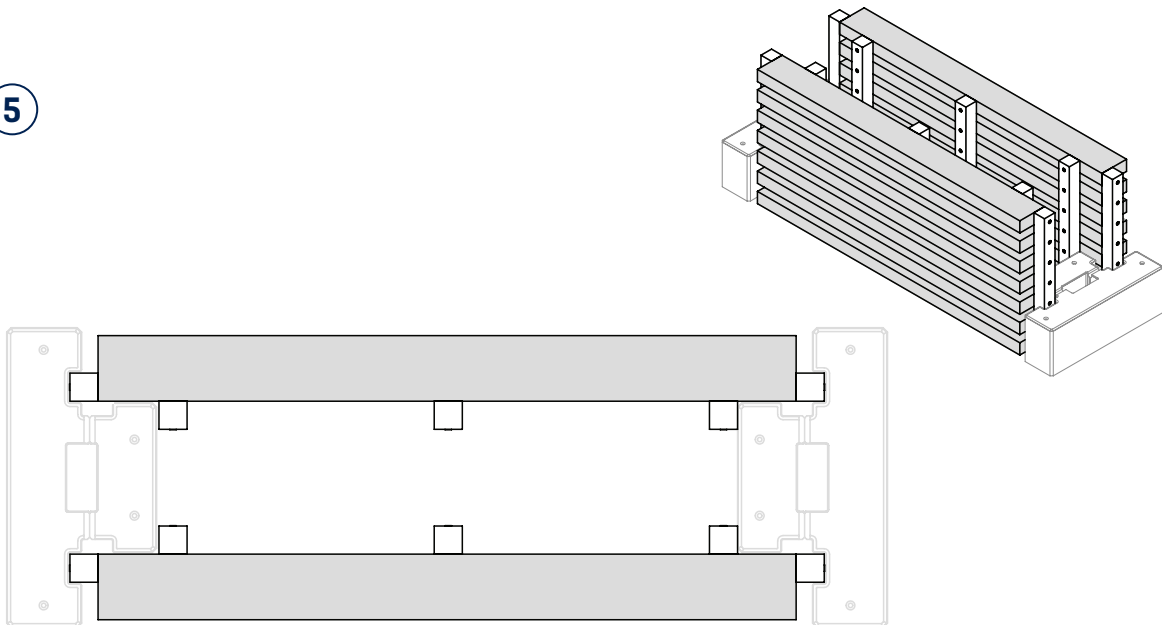

# T-BLOCK

## WOOD BENCH - 2" x 4" LUMBER

- 6 Lay down the next blocks, ensuring they sit flush into place.

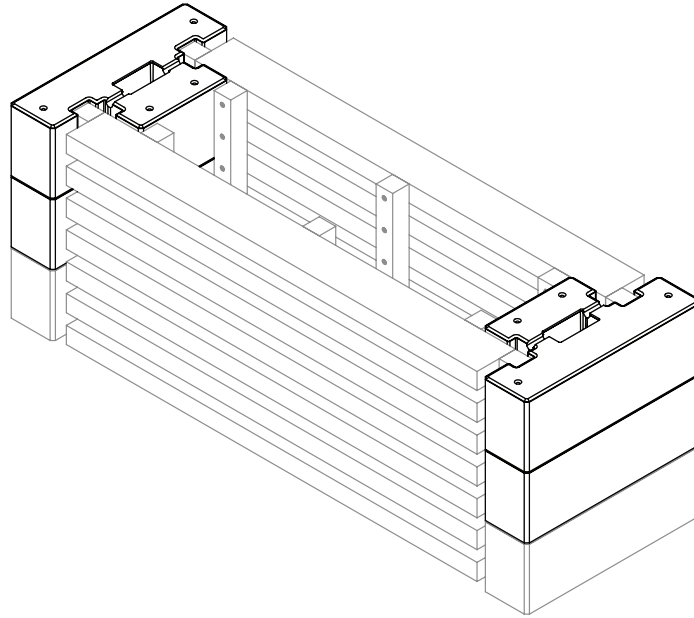

- 7 Use screws 2 1/2".

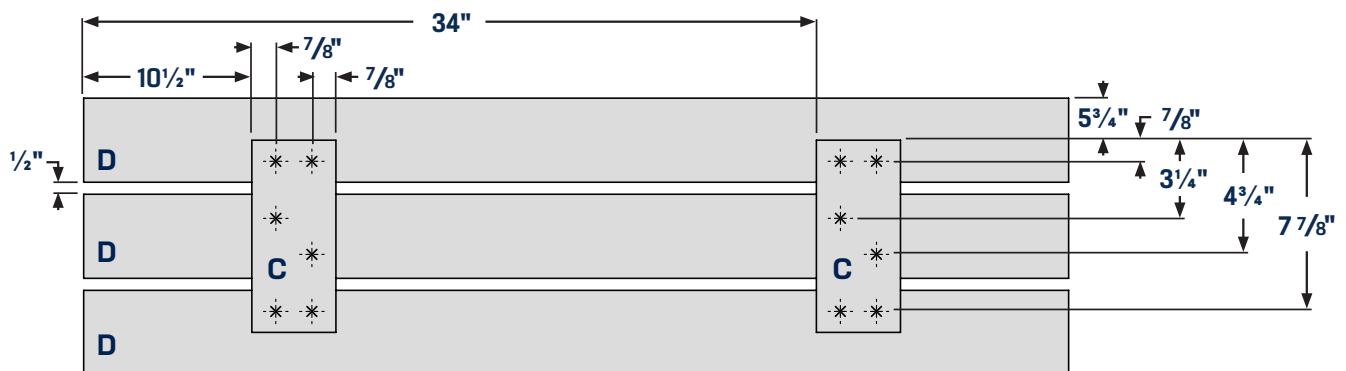
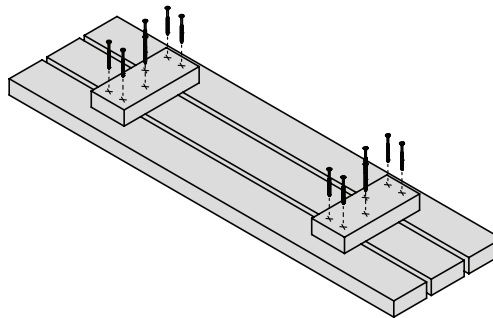

# T-BLOCK

WOOD BENCH  
- 2" x 4" LUMBER

- 8 Put the angle pieces together to form a perfect 90° L-shape, making sure the edges stay aligned and square while the glue sets.

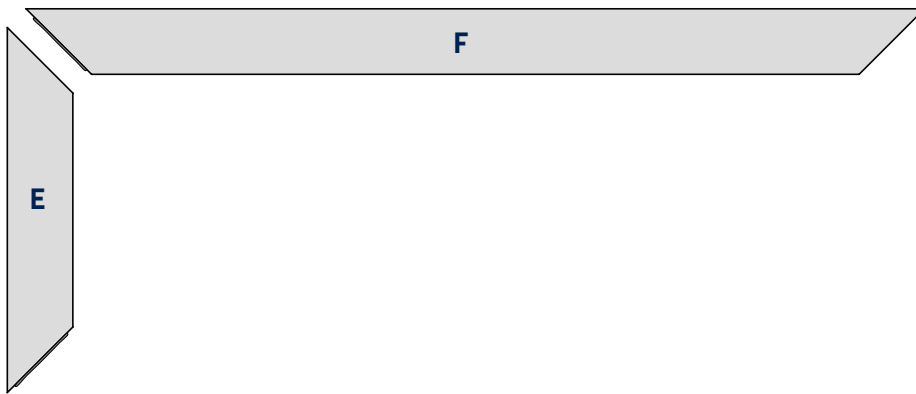
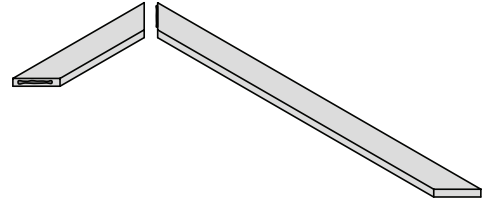

- 9 Glue the three boards onto the short side of the L-shape, placing them straight across and keeping them evenly spaced.

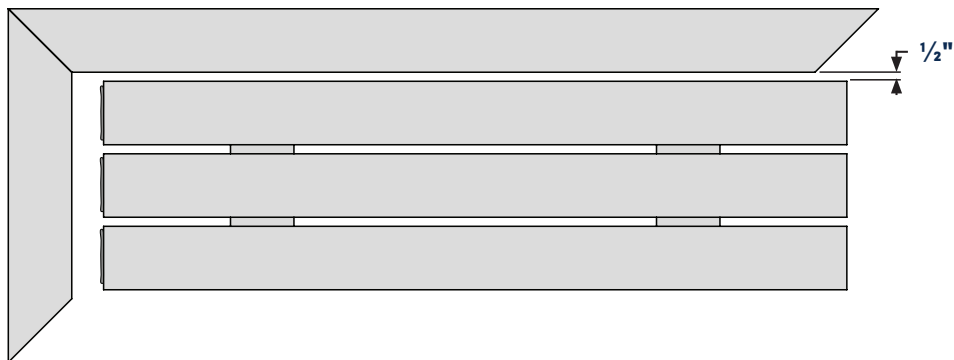
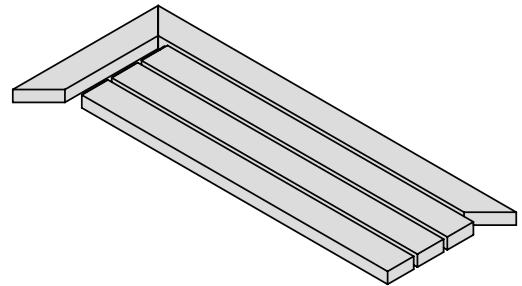

# T-BLOCK

WOOD BENCH  
- 2" x 4" LUMBER

- 10 Attach the other side piece to the boards, forming the second 90° corner. Make sure everything stay aligned while the glue sets.

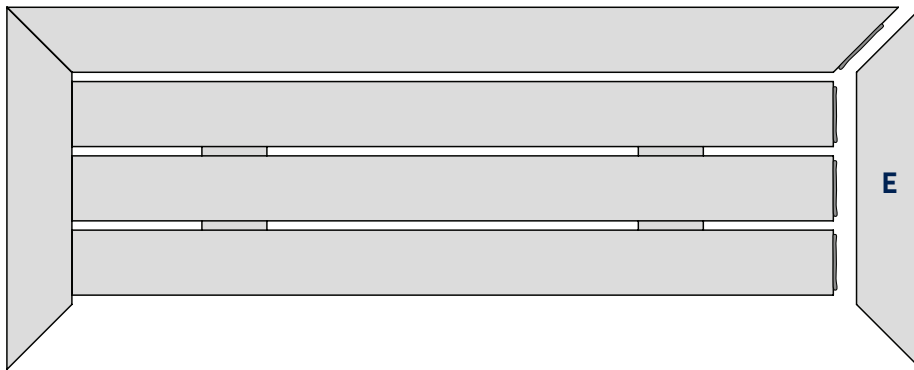
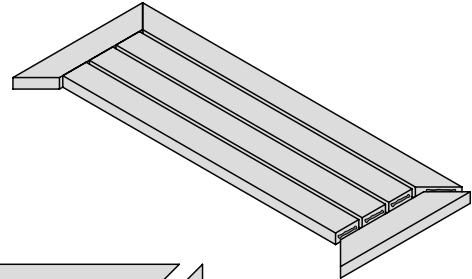

- 11 Glue the final long pieces across the top to complete the frame. Keep the edges flush and straight as the glue dries.

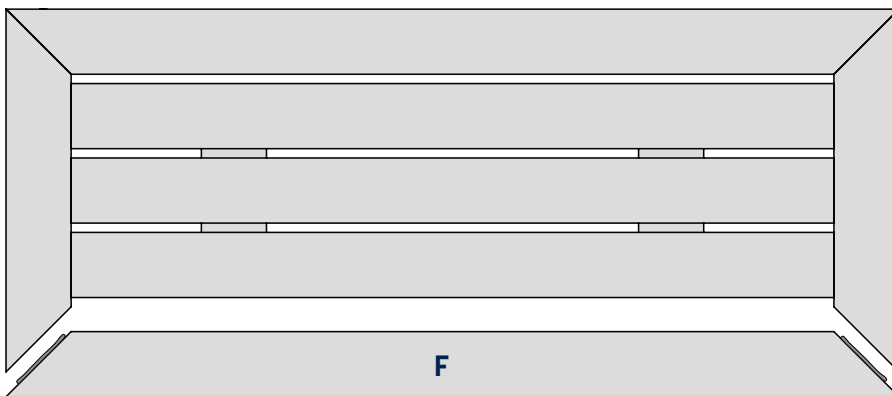
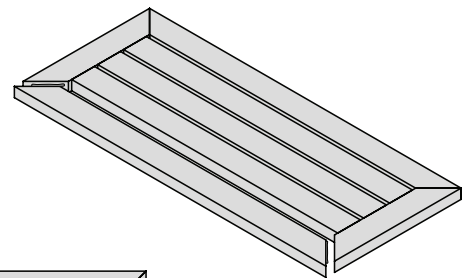

# T-BLOCK

## WOOD BENCH - 2" x 4" LUMBER

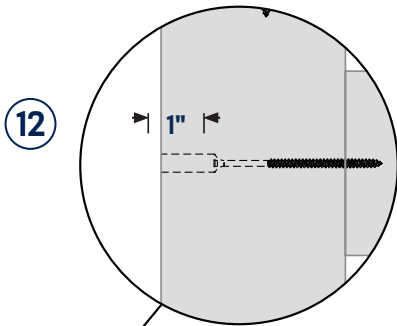

Secure the pieces with screws. Use the 3½" screws for the boards, and use the 3" screws for the corner joints.

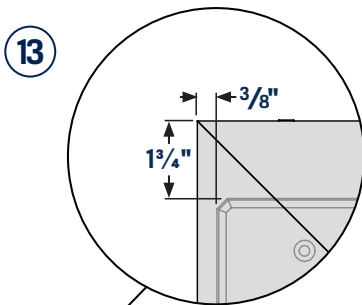
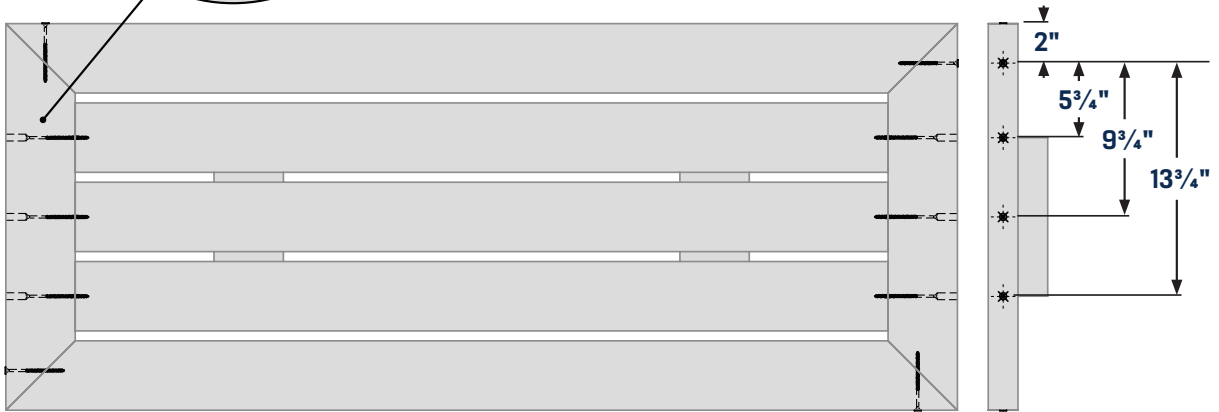

Do not forget to add glue in the cavities and on top of the side panels before laying down the seat.

