



BELGARD®
PAVES THE WAY™

T-BLOCK



**TWO LEVEL
L-PLANTER**

T-BLOCK

COMPLETE THIS STEP
FIRST FOR ALL PROJECTS

BASE PREPARATION

Always level ground before installation

ON NEW OR EXISTING PATIO

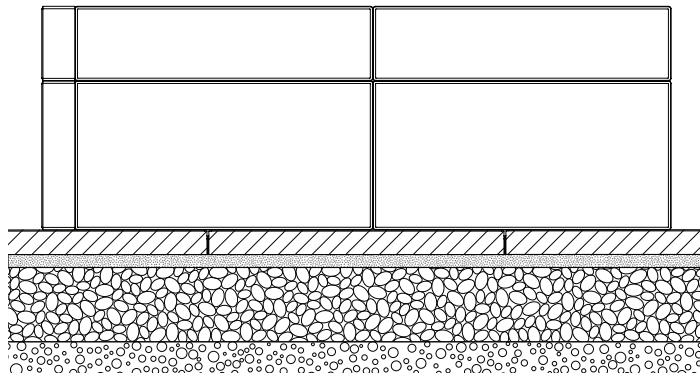

SLAB OR PAVER

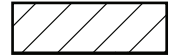

BEDDING SAND 1"

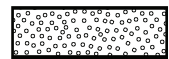

COMPACTED AGGREGATES 6"-8"



SOIL

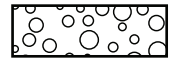

ON POURED CONCRETE

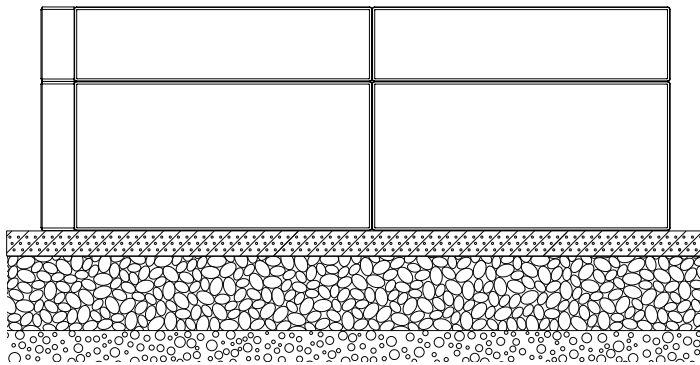

REINFORCED POURED CONCRETE FOUNDATION 2"

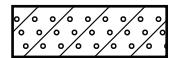

COMPACTED AGGREGATES 6"-8"



SOIL



ON COMPACTED FOUNDATION

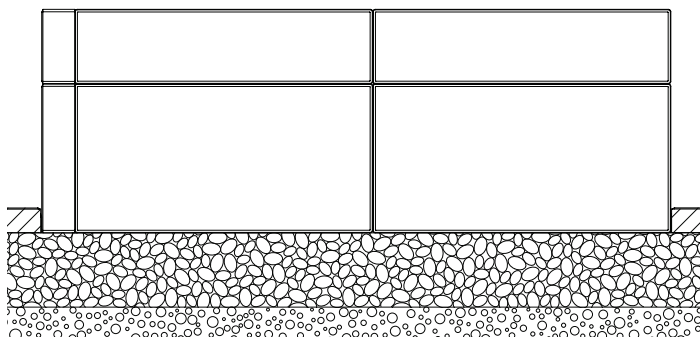

SLAB OR PAVER

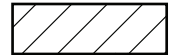

COMPACTED AGGREGATES 6"-8"



SOIL



T-BLOCK

TWO LEVEL
L-PLANTER

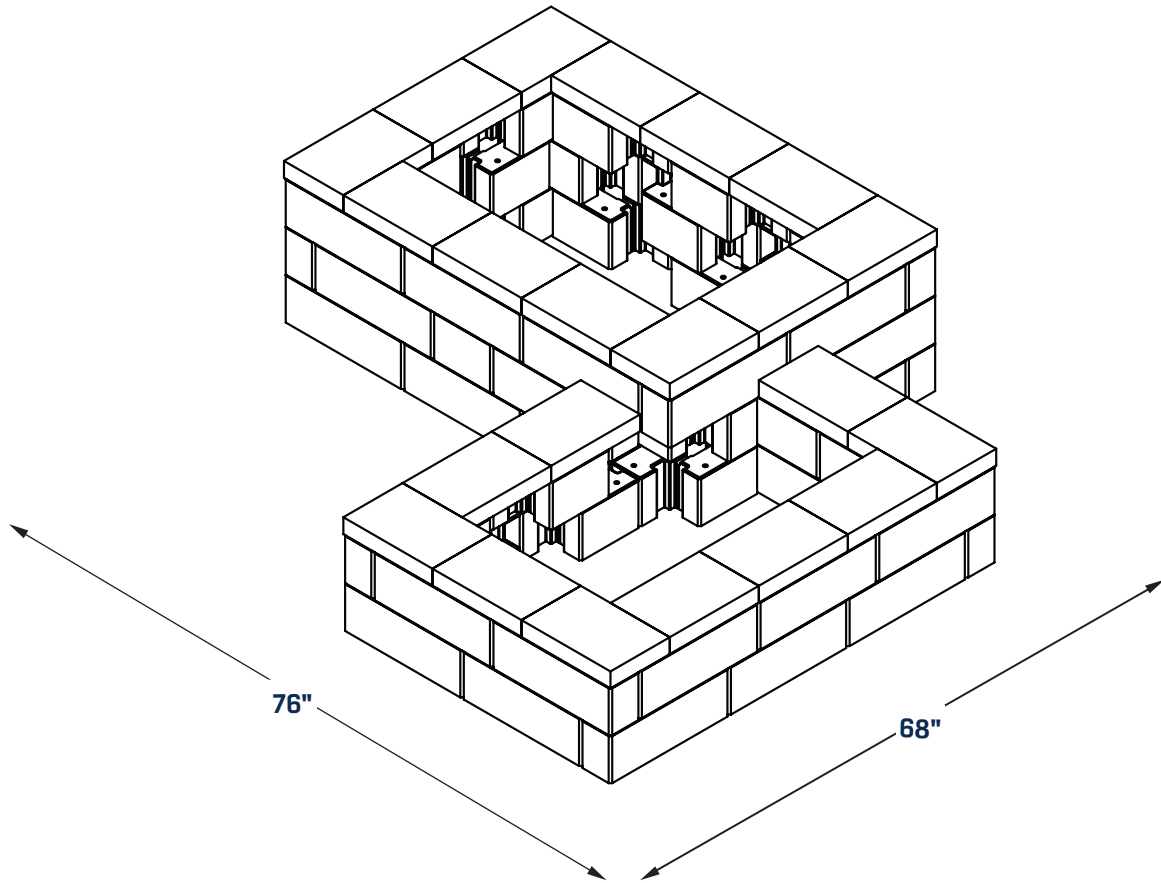

COMPONENTS

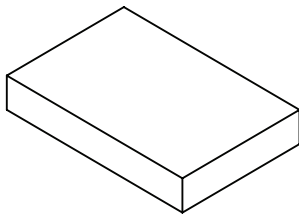

Cap (x22)

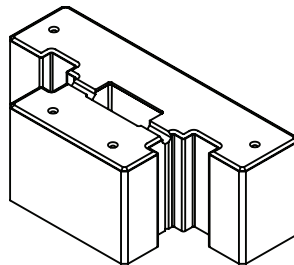

T-Block (x48)



Glue Tube

T-BLOCK

TWO LEVEL L-PLANTER

REQUIRED TOOLS

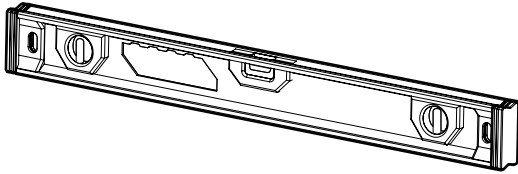

LEVEL

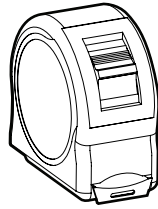

**MEASURING
TAPE**

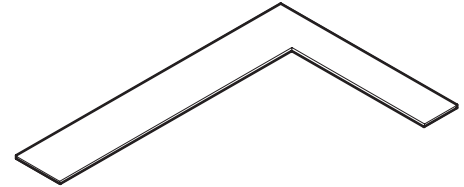

**CARPENTER
SQUARE**

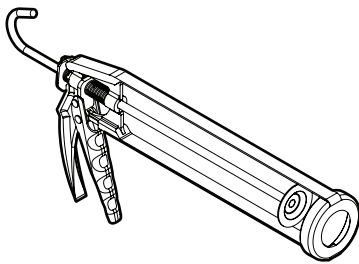

**SILICONE
GUN**

SAFETY EQUIPMENT



SAFETY BOOTS

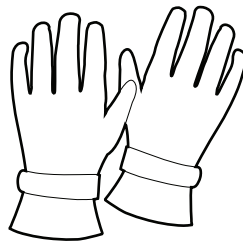

GLOVES

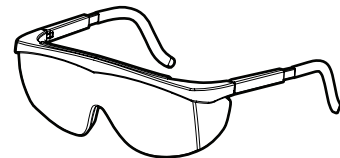

SAFETY GLASSES

T-BLOCK

TWO LEVEL L-PLANTER

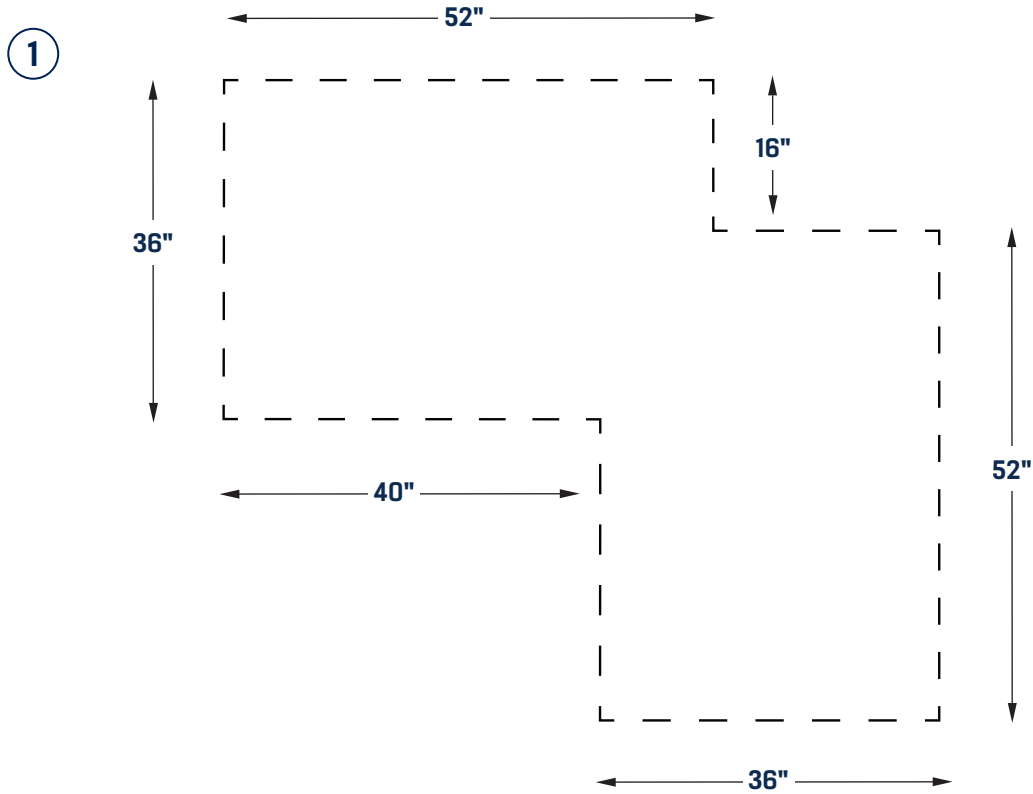

- ② Do not forget to add glue in the cavities before laying down your next level.

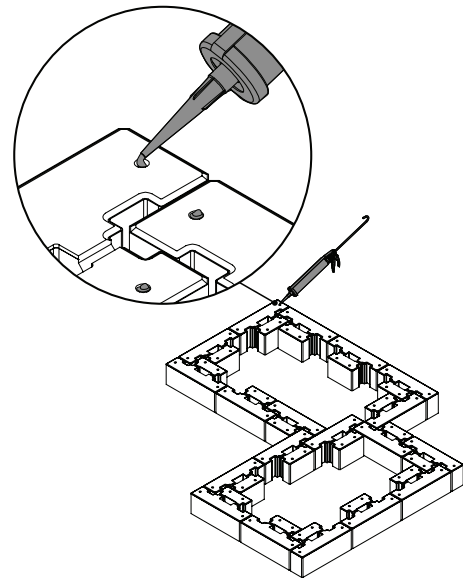
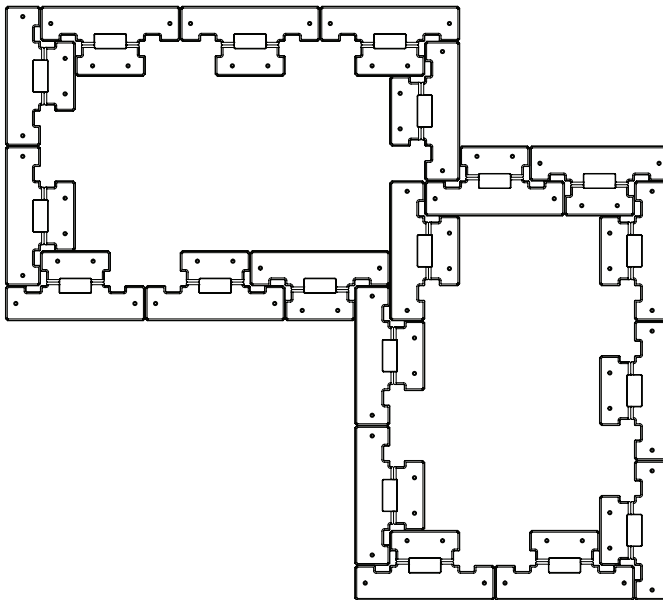

T-BLOCK

TWO LEVEL L-PLANTER

- 3 Do not forget to add glue in the cavities before laying down your next level.

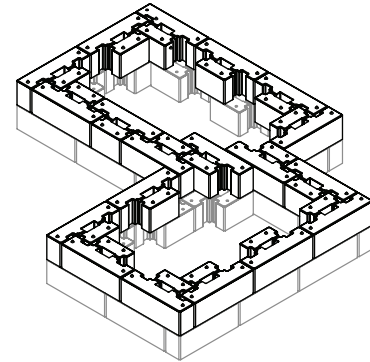
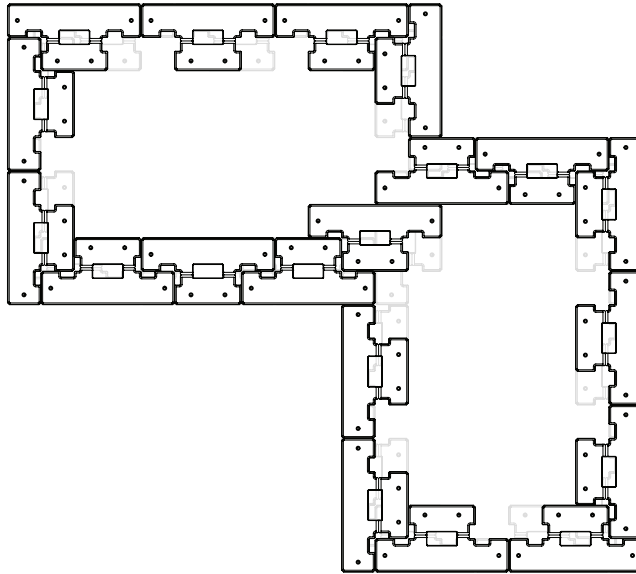

- 4 Do not forget to add glue in the cavities before laying down your next level.

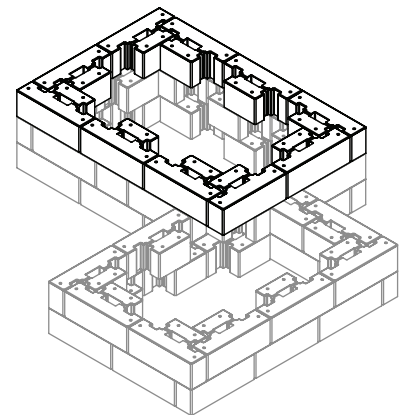
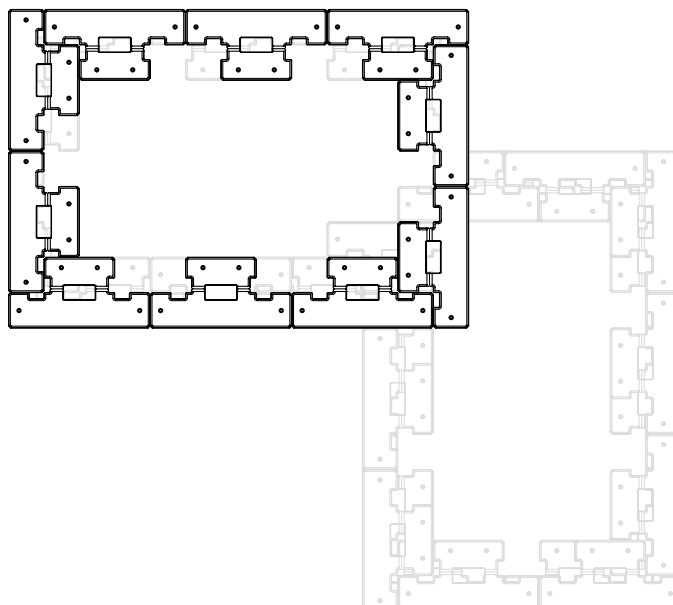

T-BLOCK

TWO LEVEL L-PLANTER

- 5 Do not forget to add glue in the cavities before laying down your next level.

