



BELGARD®
PAVES THE WAY™

T-BLOCK



**TWO BENCHES WITH
SQUARE PLANTER**

T-BLOCK

COMPLETE THIS STEP
FIRST FOR ALL PROJECTS

BASE PREPARATION

Always level ground before installation

ON NEW OR EXISTING PATIO

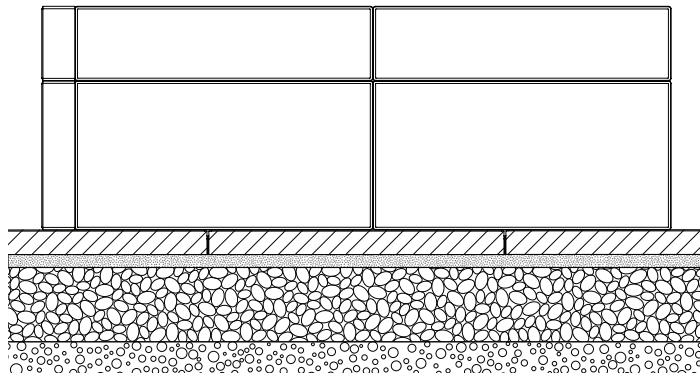

SLAB OR PAVER

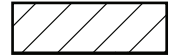

BEDDING SAND 1"

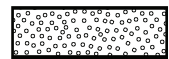

COMPACTED AGGREGATES 6"-8"



SOIL

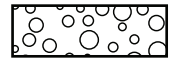

ON POURED CONCRETE

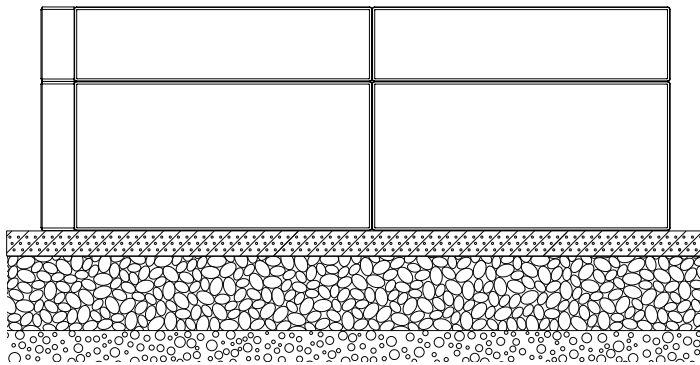

REINFORCED POURED CONCRETE FOUNDATION 2"

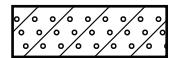

COMPACTED AGGREGATES 6"-8"



SOIL



ON COMPACTED FOUNDATION

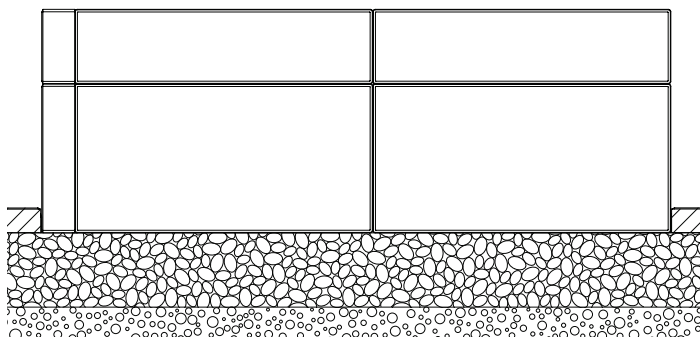

SLAB OR PAVER



COMPACTED AGGREGATES 6"-8"



SOIL



T-BLOCK

TWO BENCHES WITH
SQUARE PLANTER

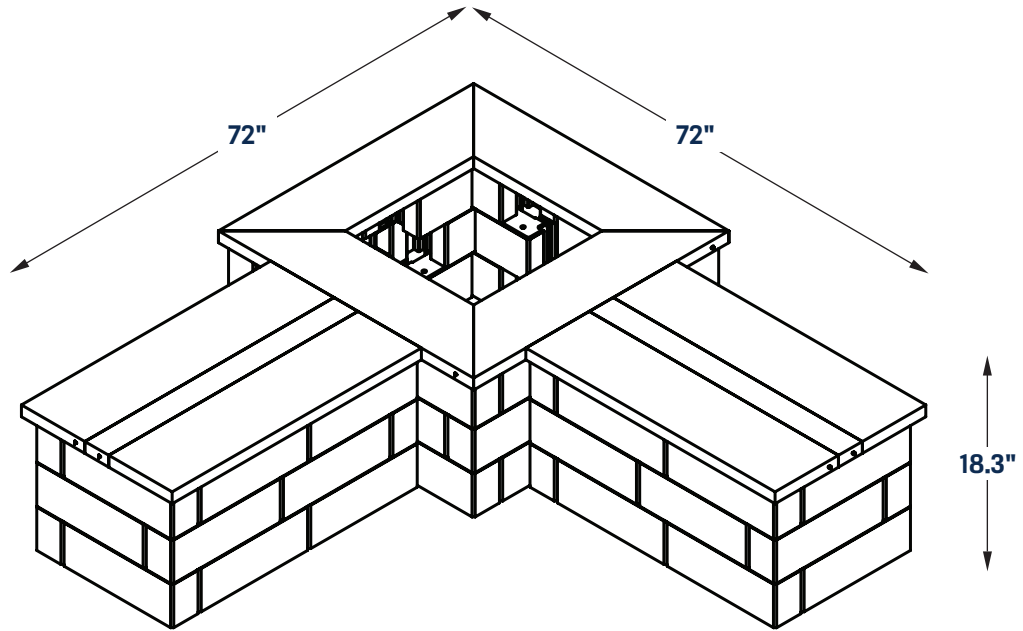

COMPONENTS

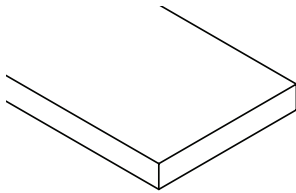

2" x 10" x 8' (x4)

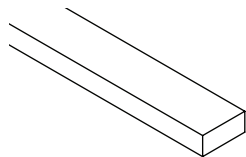

2" x 4" x 8' (x1)



Glue Tube

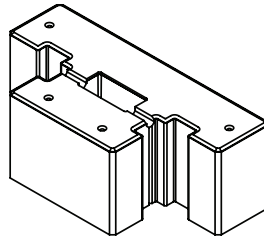

T-Block (x60)



No.8 x 2 1/2" (x12)



No.8 x 3" (x8)

T-BLOCK

TWO BENCHES WITH SQUARE PLANTER

REQUIRED TOOLS

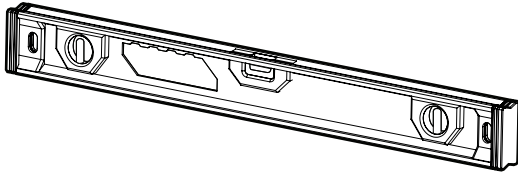

LEVEL

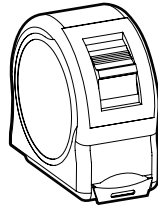

**MEASURING
TAPE**

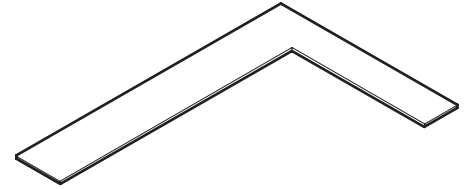

**CARPENTER
SQUARE**

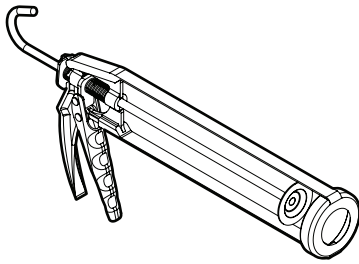

**SILICONE
GUN**

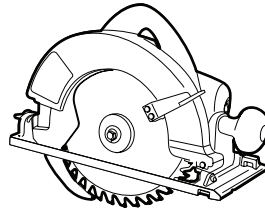

SKILSAW

SAFETY EQUIPMENT



SAFETY BOOTS

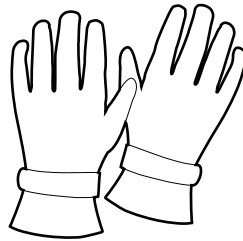

GLOVES

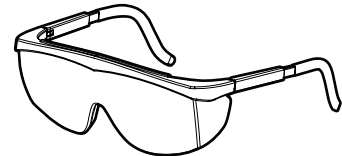

SAFETY GLASSES

T-BLOCK

TWO BENCHES WITH SQUARE PLANTER

1

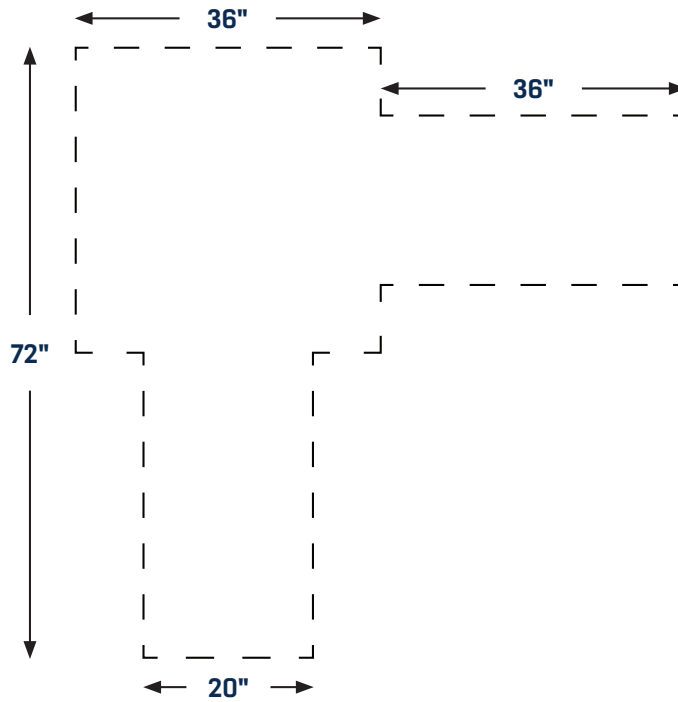

2

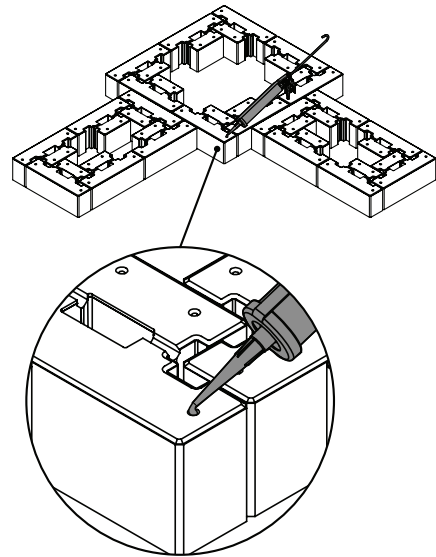
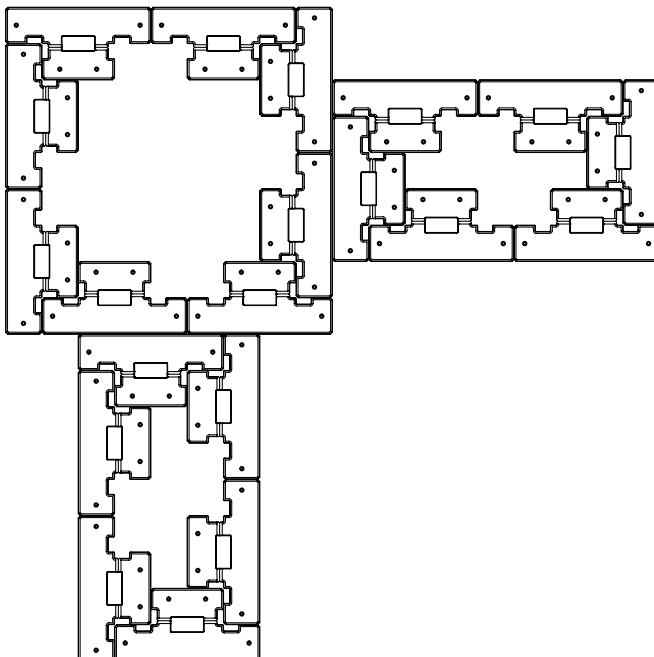

Do not forget to add glue in the cavities before laying down your next level.

T-BLOCK

TWO BENCHES WITH SQUARE PLANTER

3

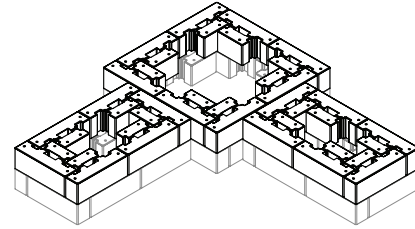
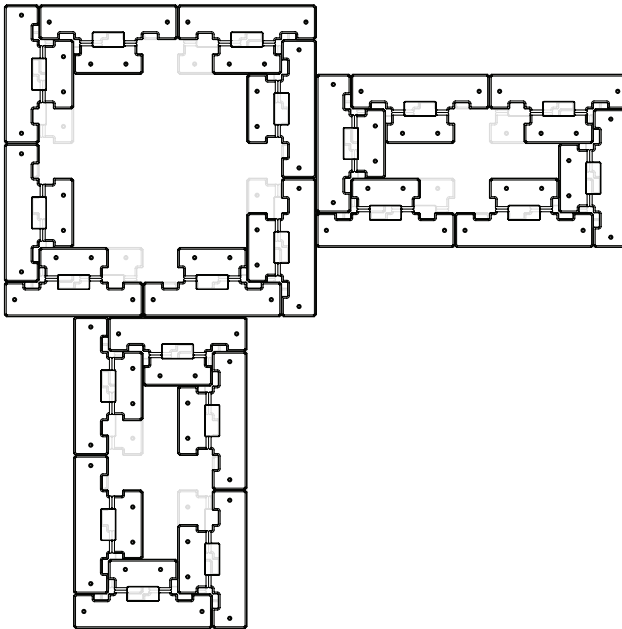

Do not forget to add glue in the cavities before laying down your next level.

4

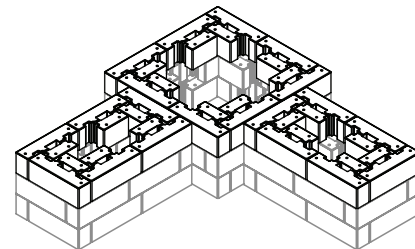
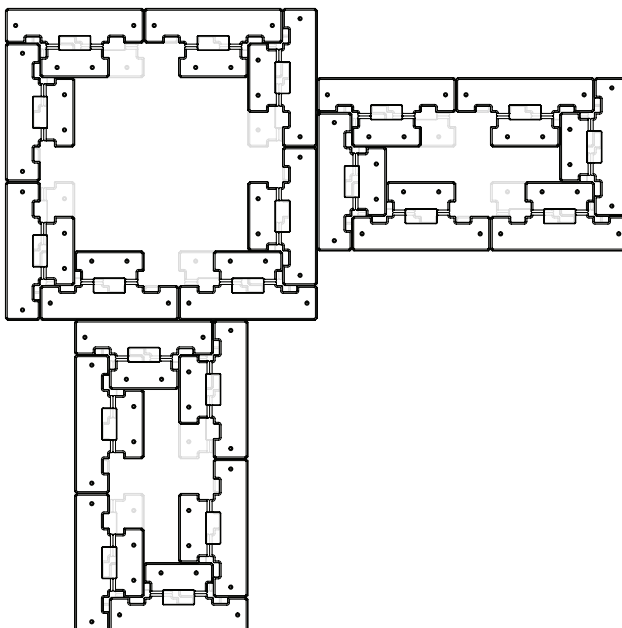

Do not forget to add glue in the cavities before laying down your next level.

T-BLOCK

TWO BENCHES WITH SQUARE PLANTER

WOOD CUTS

- 2" x 4" x 8' A = 35⁷/₈" C = 35⁷/₈"
- 2" x 10" x 8' B = 11³/₄" D = 37¹/₄"

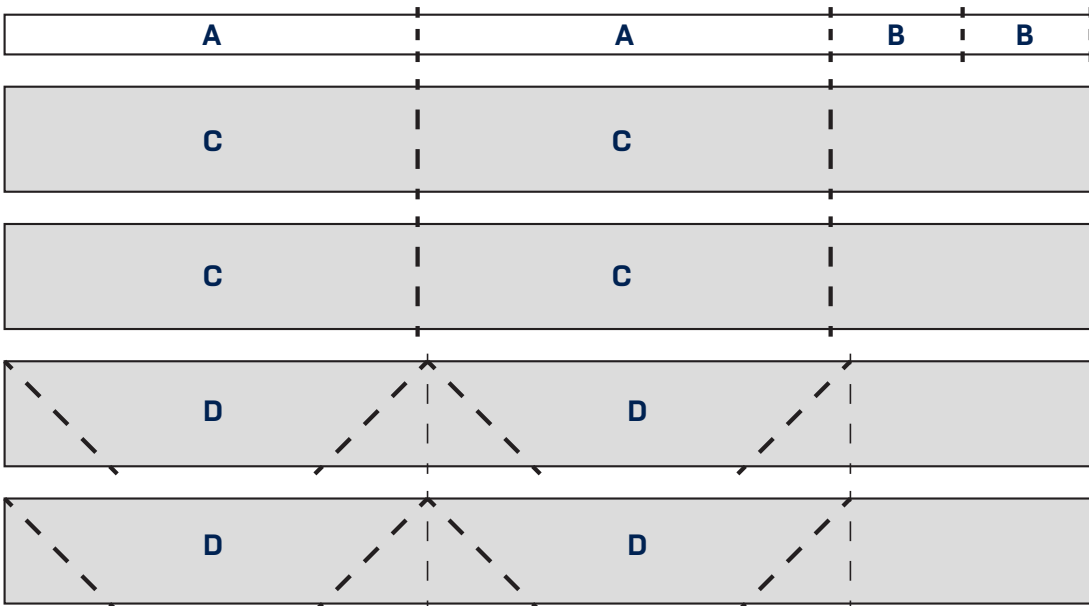
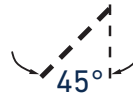

5

Use screws (2¹/₄") 2X

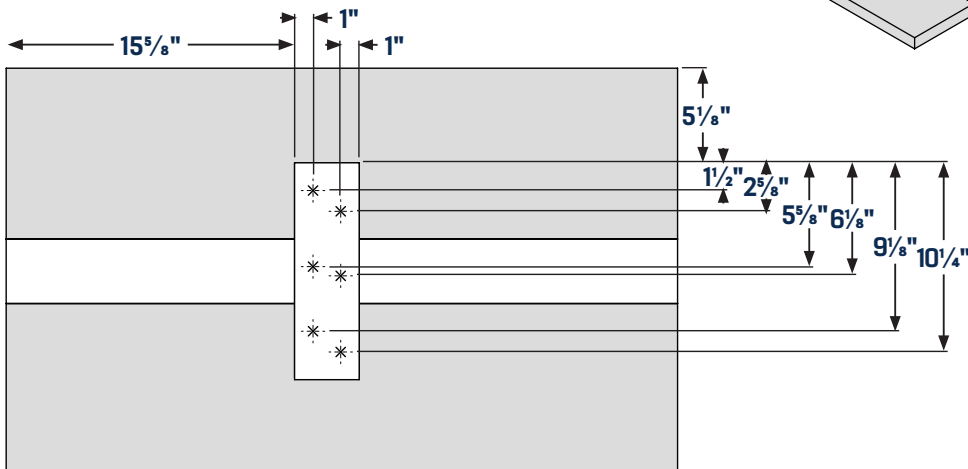
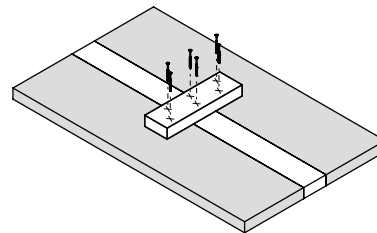

T-BLOCK

TWO BENCHES WITH SQUARE PLANTER

6

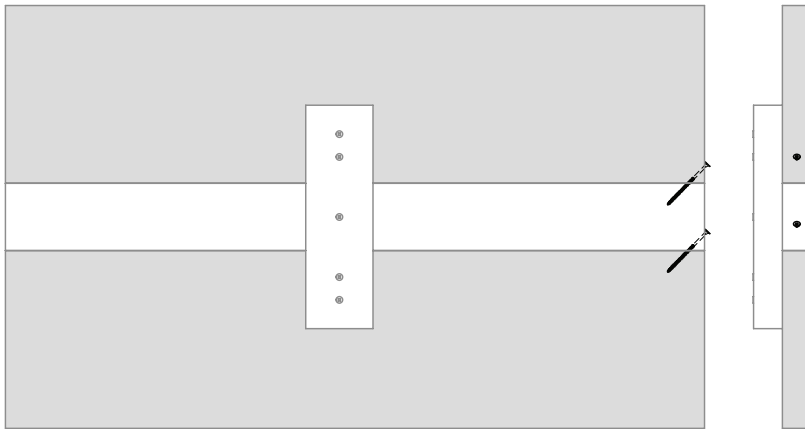

Attach the planks using screws (3") at a 45° angle. Make sure each screw is placed in the middle of the lumber so it connects both boards securely. 2X

7

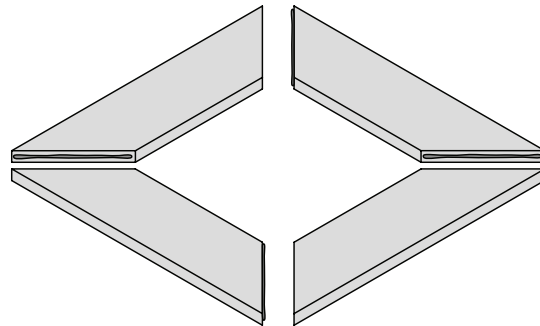
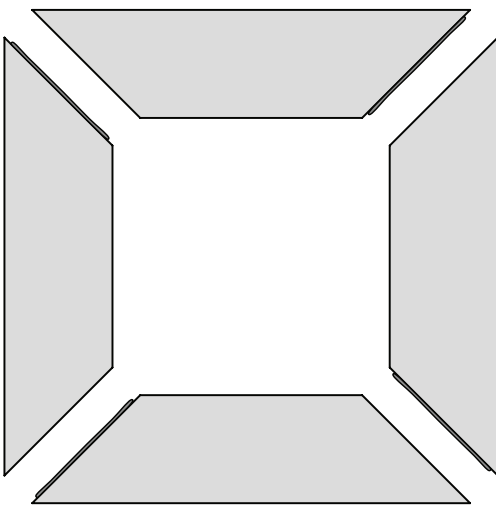

Put the angle pieces together to create the frame shape, keeping all edges aligned while the glue sets.

T-BLOCK

TWO BENCHES WITH SQUARE PLANTER

8

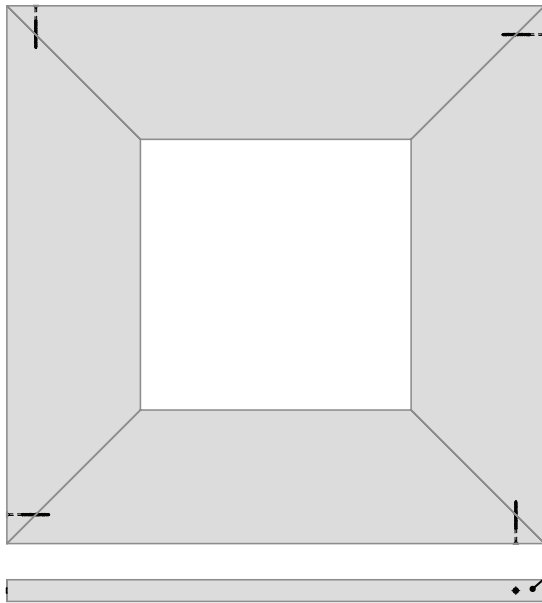

Add the screws (3") in each corner, making sure they go through the middle of the boards for a solid connection.

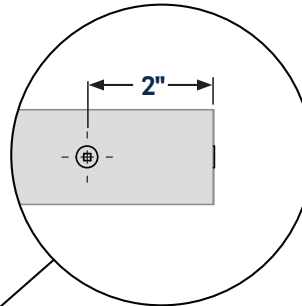

9

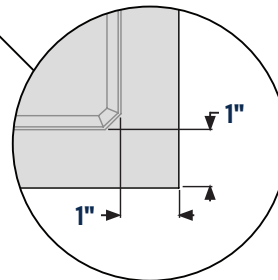
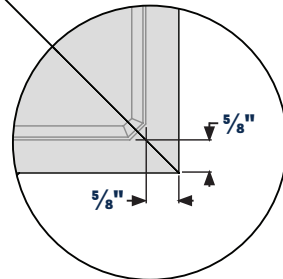
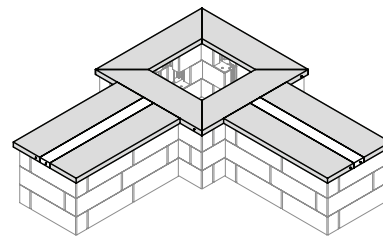
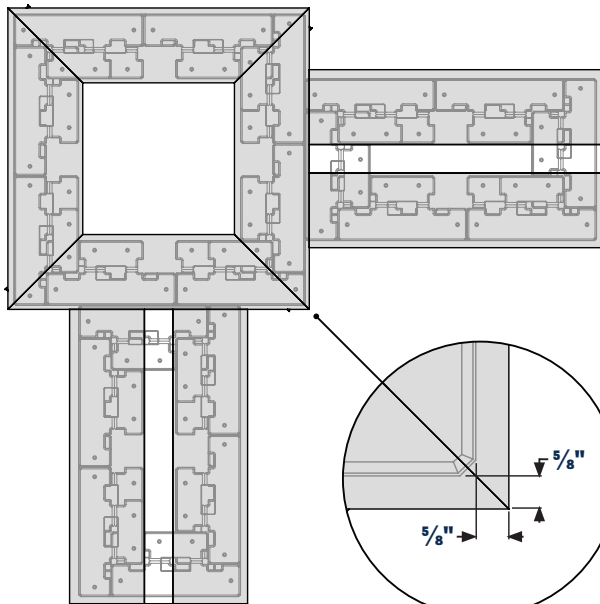

Do not forget to add glue in the cavities before laying down the frame and seat.