



BELGARD®  
PAVES THE WAY™

# T-BLOCK



**THREE LEVEL  
L-PLANTER**

# T-BLOCK

COMPLETE THIS STEP  
FIRST FOR ALL PROJECTS

## BASE PREPARATION

Always level ground before installation

### ON NEW OR EXISTING PATIO

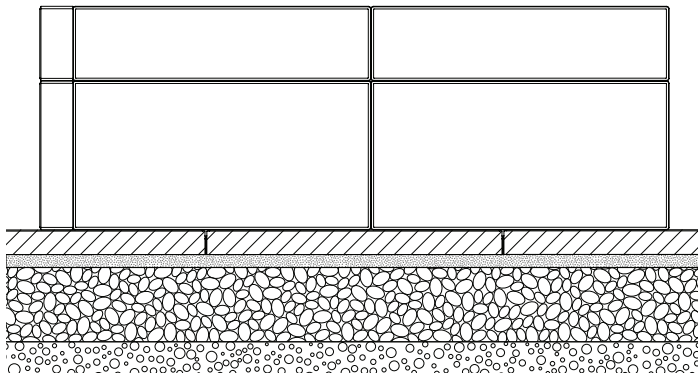

### SLAB OR PAVER

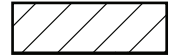

### BEDDING SAND 1"

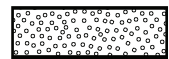

### COMPACTED AGGREGATES 6"-8"



### SOIL

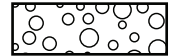

### ON POURED CONCRETE

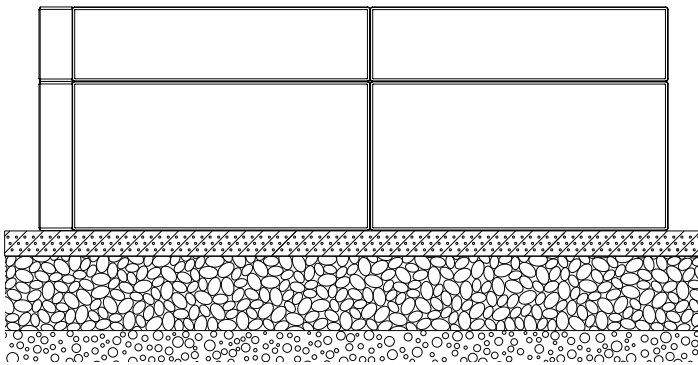

### REINFORCED POURED CONCRETE FOUNDATION 2"

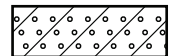

### COMPACTED AGGREGATES 6"-8"



### SOIL



### ON COMPACTED FOUNDATION

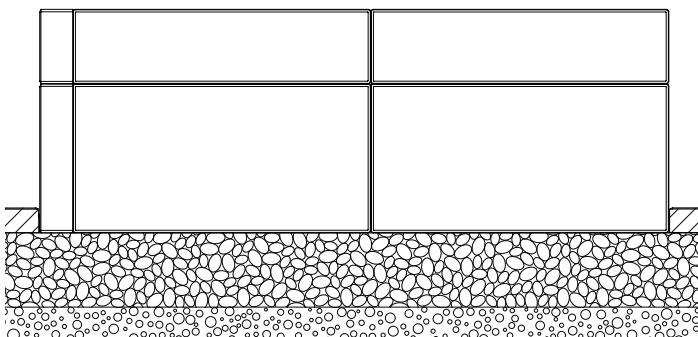

### SLAB OR PAVER



### COMPACTED AGGREGATES 6"-8"



### SOIL

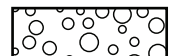

# T-BLOCK

## THREE LEVEL L-PLANTER

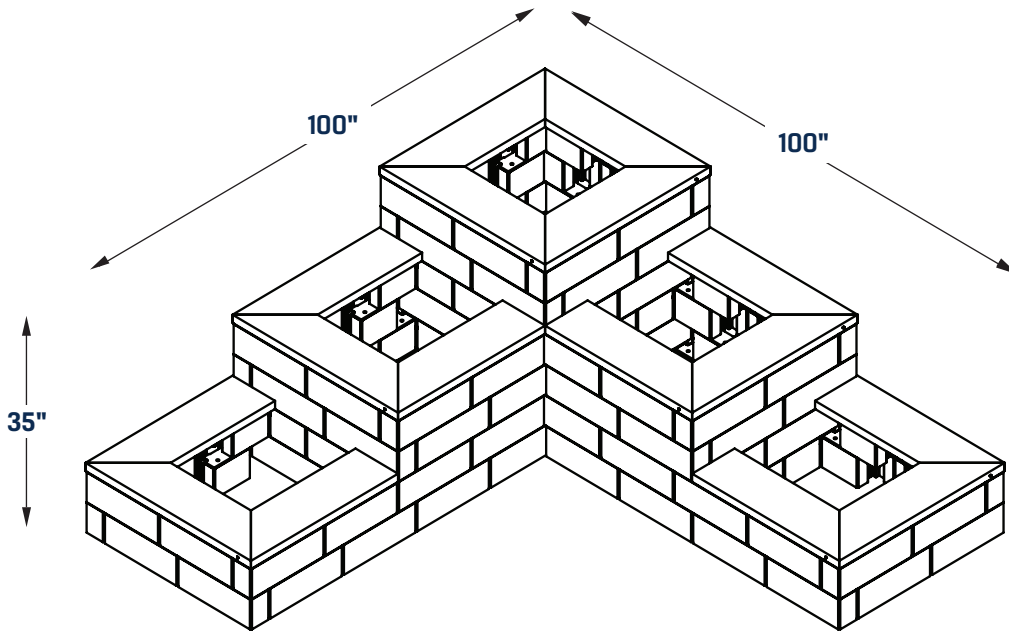

### COMPONENTS

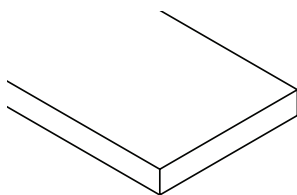

2" x 10" x 8' (x8)

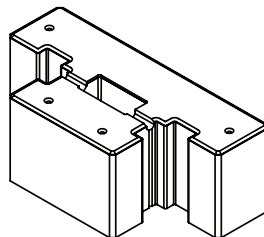

T-Block (x120)



Glue Tube



No. 8 x 3" (x12)

# T-BLOCK

## THREE LEVEL L-PLANTER

### REQUIRED TOOLS

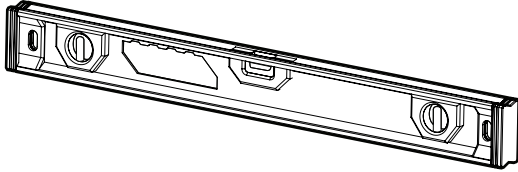

**LEVEL**

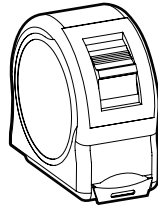

**MEASURING  
TAPE**

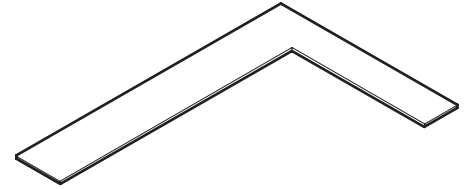

**CARPENTER  
SQUARE**

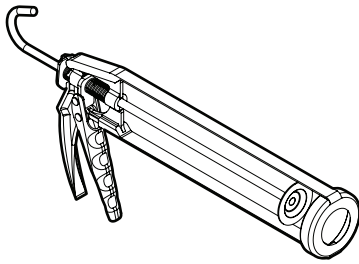

**SILICONE  
GUN**

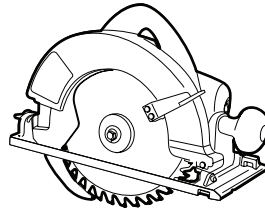

**SKILSAW**

### SAFETY EQUIPMENT



**SAFETY BOOTS**

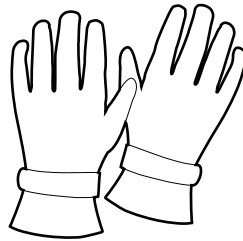

**GLOVES**

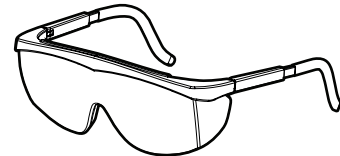

**SAFETY GLASSES**

# T-BLOCK

## THREE LEVEL L-PLANTER

1

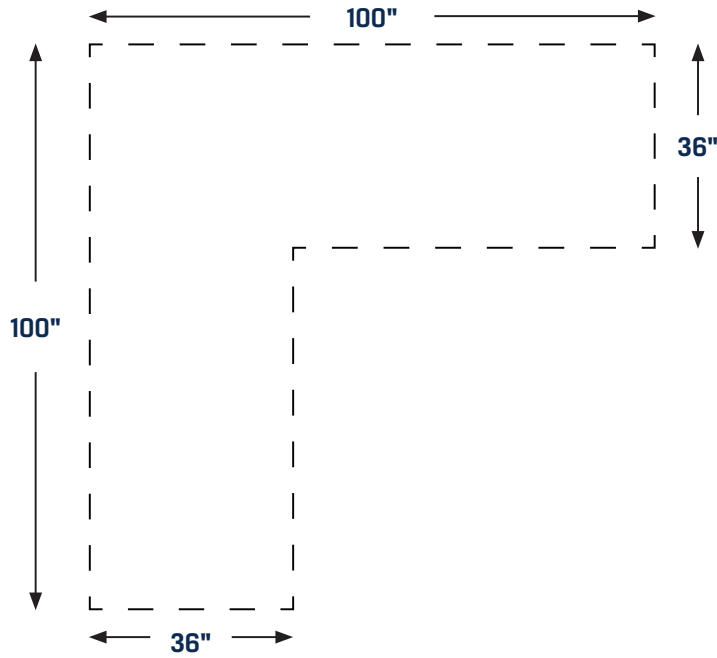

2

Do not forget to add glue in the cavities before laying down your next level.

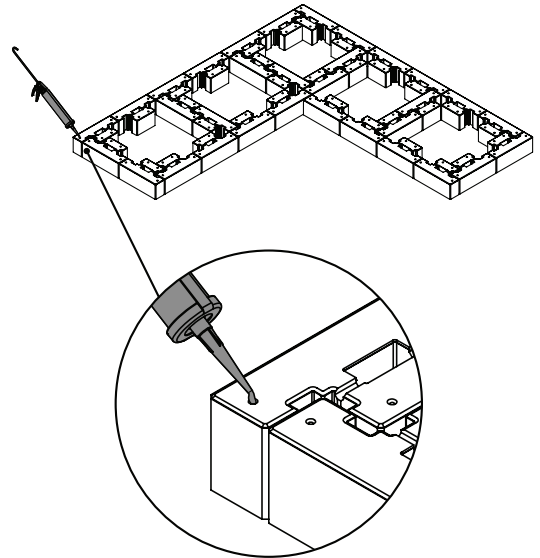
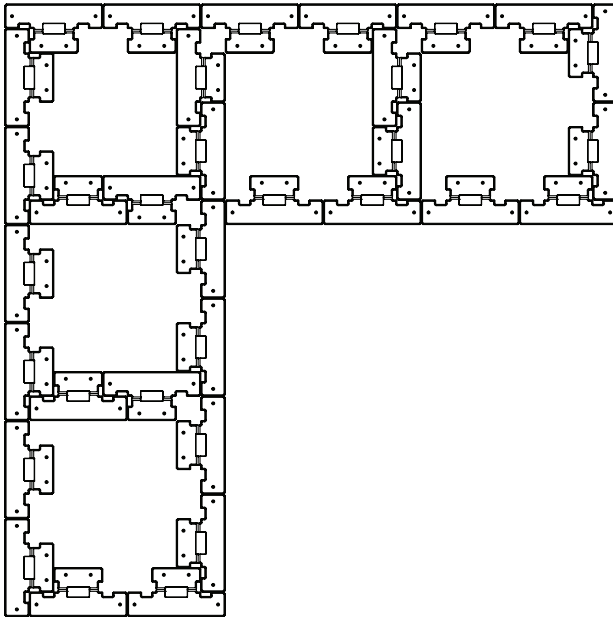

# T-BLOCK

## THREE LEVEL L-PLANTER

3

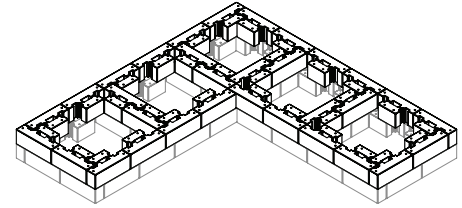
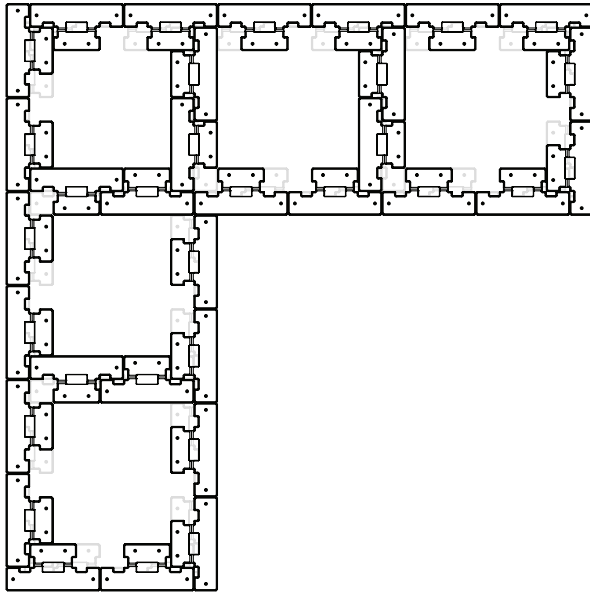

Do not forget to add glue in the cavities before laying down your next level.

4

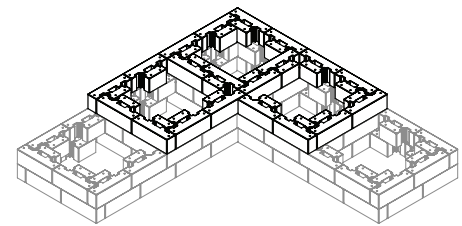
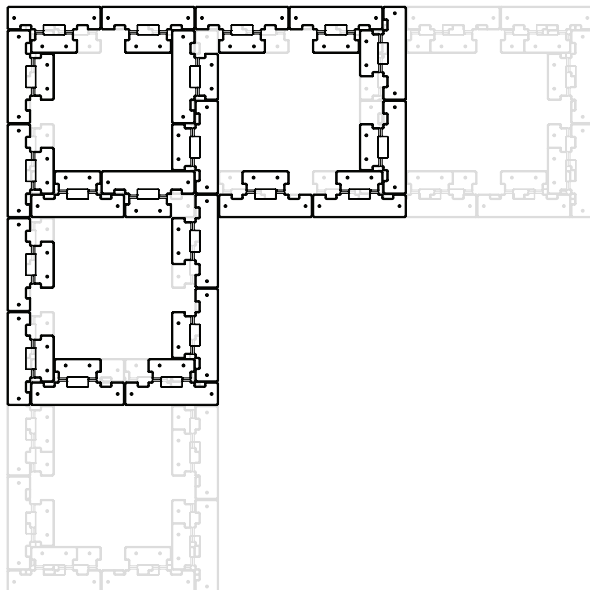

Do not forget to add glue in the cavities before laying down your next level.

# T-BLOCK

## THREE LEVEL L-PLANTER

5

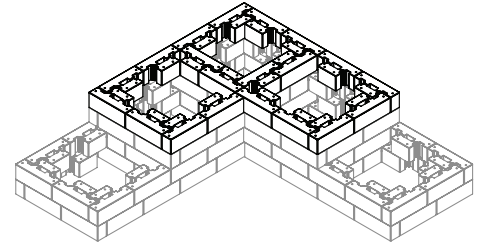
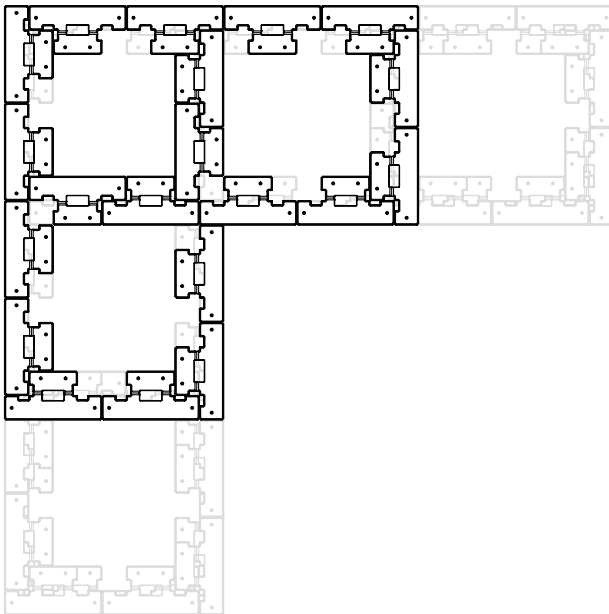

Do not forget to add glue in the cavities before laying down your next level.

6

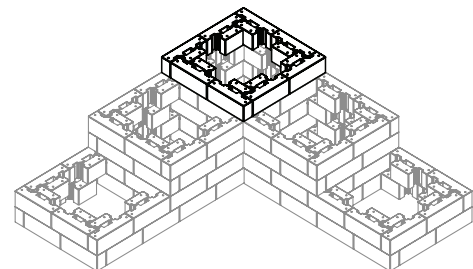
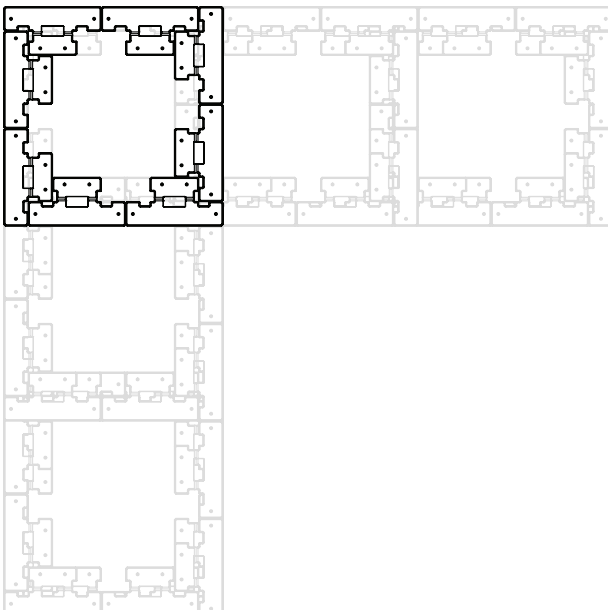

Do not forget to add glue in the cavities before laying down your next level.

# T-BLOCK

## THREE LEVEL L-PLANTER

7

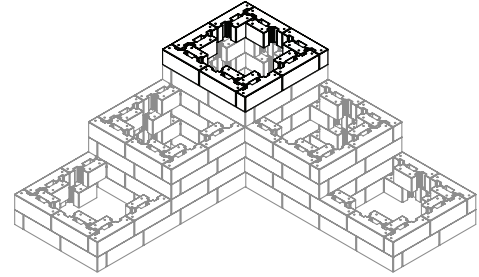
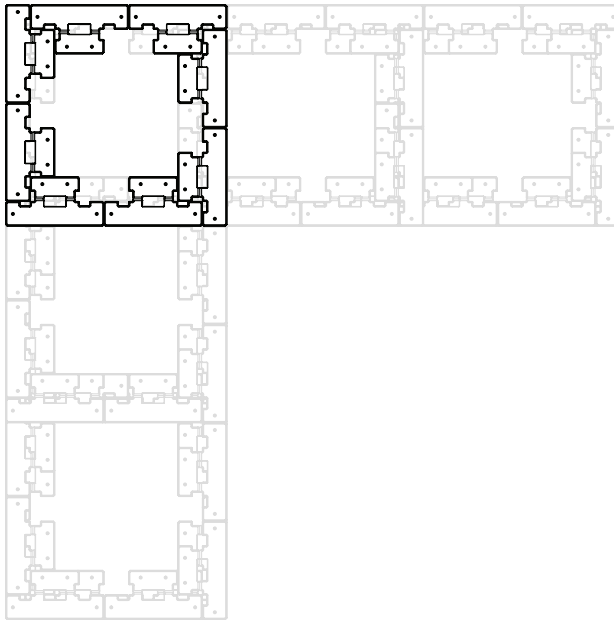

Do not forget to add glue in the cavities before laying down your next level.

### WOOD CUTS

□ 2" x 10" x 8'

A = 37 $\frac{1}{4}$ "

B = 31 $\frac{7}{8}$ "

C = 31 $\frac{7}{8}$ "

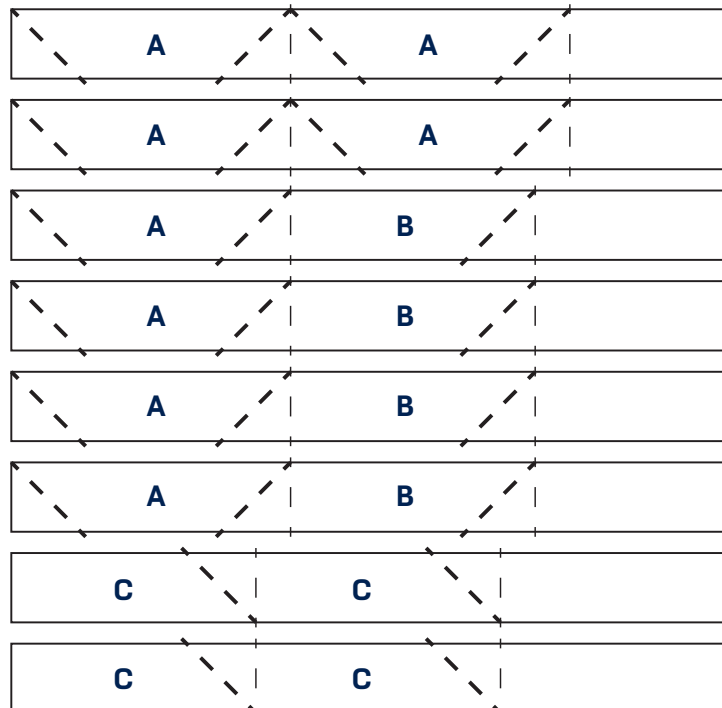
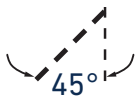

# T-BLOCK

## THREE LEVEL L-PLANTER

8

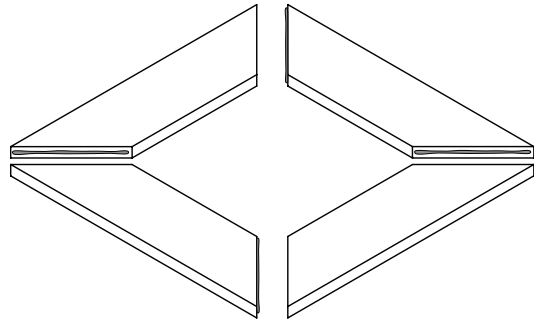
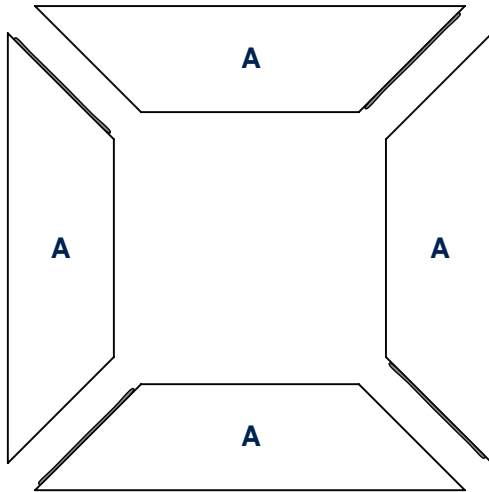

Put the angle pieces together to create the frame shape, keeping all edges aligned while the glue sets.

9

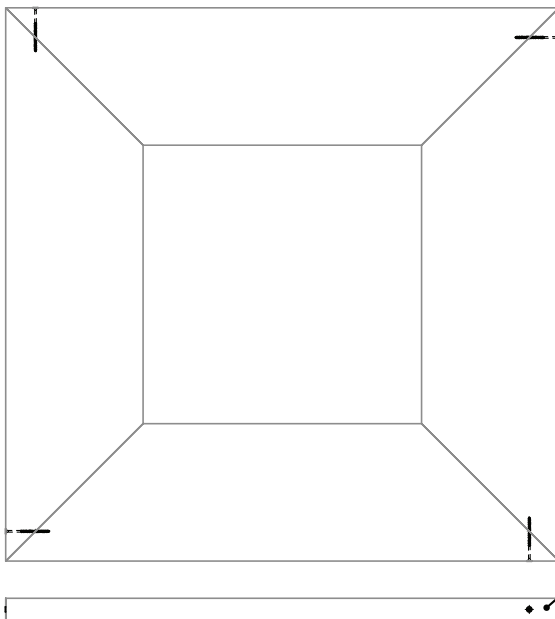

Add the screws in each corner, making sure they go through the middle of the boards for a solid connection.

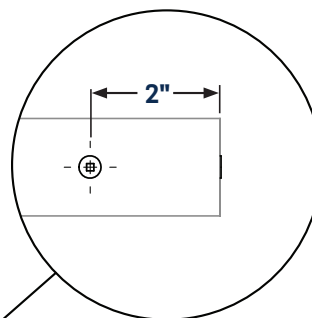

# T-BLOCK

## THREE LEVEL L-PLANTER

10

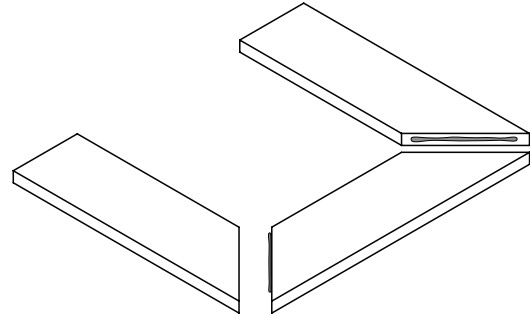
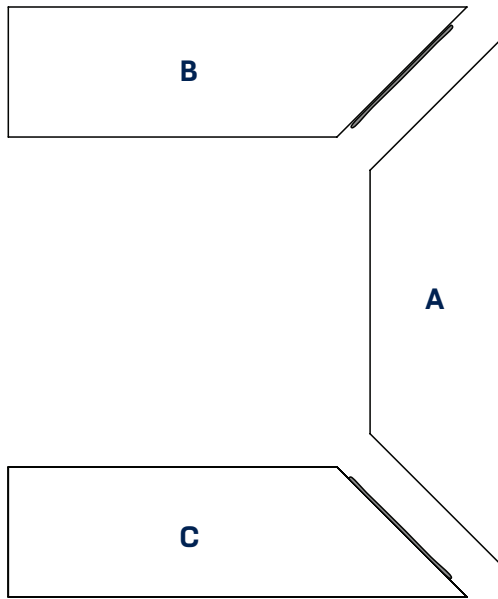

Put the angle pieces together to create the frame shape, keeping all edges aligned while the glue sets. 4x

11

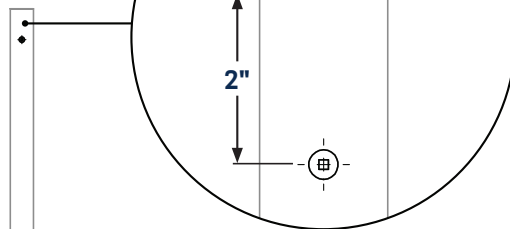
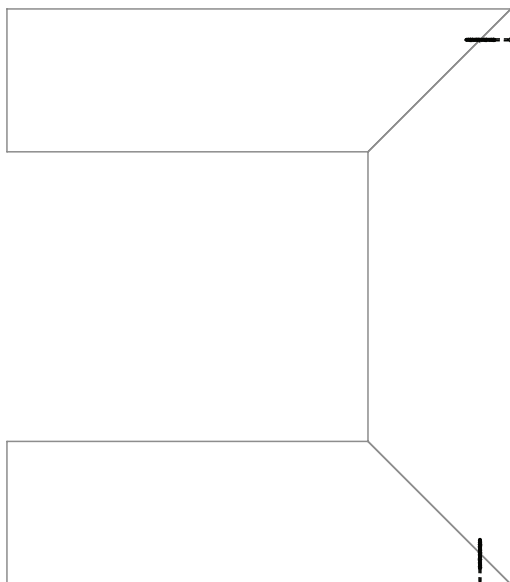

Add the screws in each corner, making sure they go through the middle of the boards for a solid connection. 4x

# T-BLOCK

## THREE LEVEL L-PLANTER

10

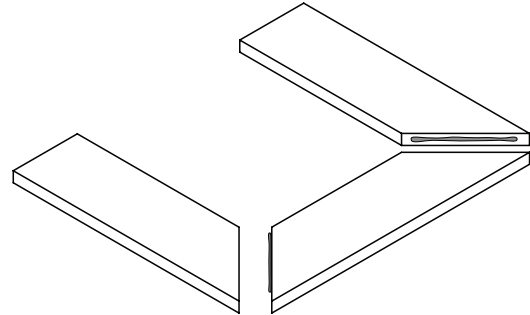
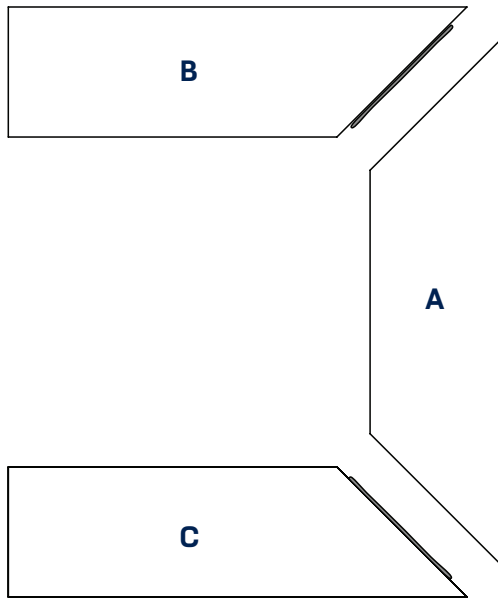

Put the angle pieces together to create the frame shape, keeping all edges aligned while the glue sets. 4x

11

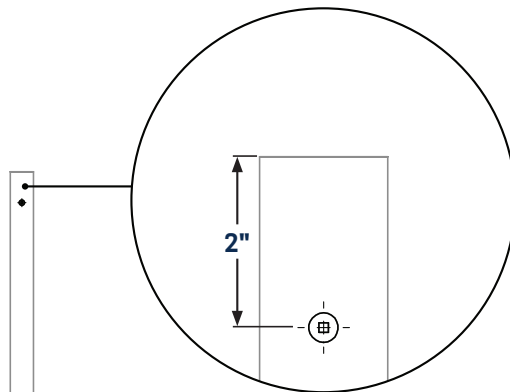
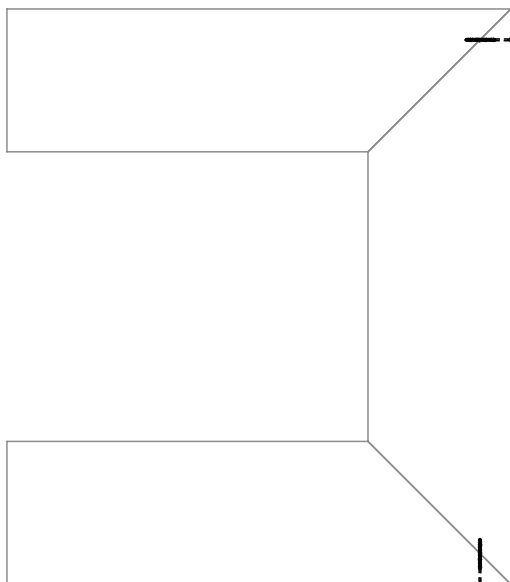

Add the screws in each corner, making sure they go through the middle of the boards for a solid connection. 4x

# T-BLOCK

## THREE LEVEL L-PLANTER

12

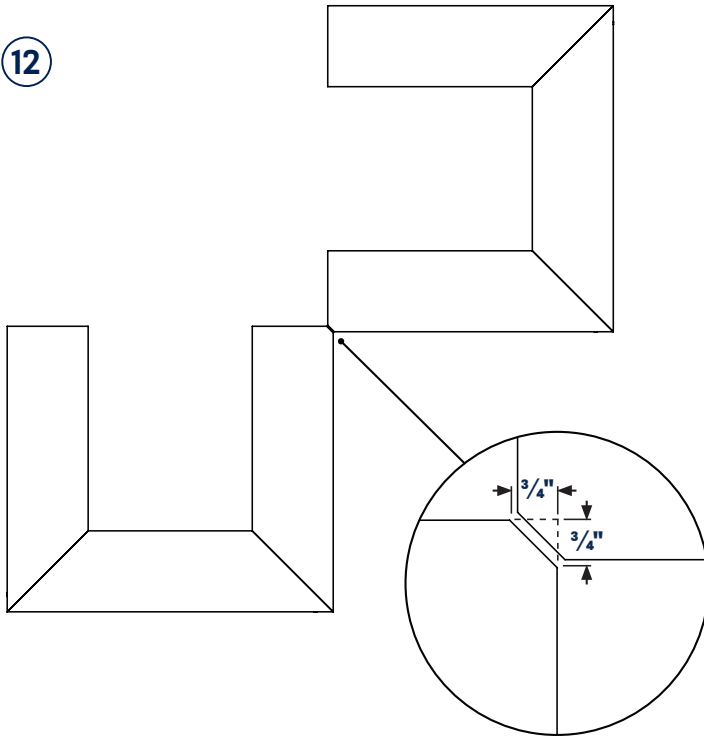

Trim the inside corners of the frames of the second level planters so they don't touch, ensuring the frames fit together cleanly and sit flush.

13

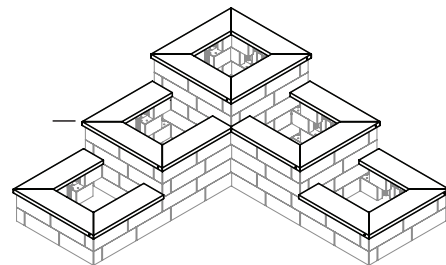
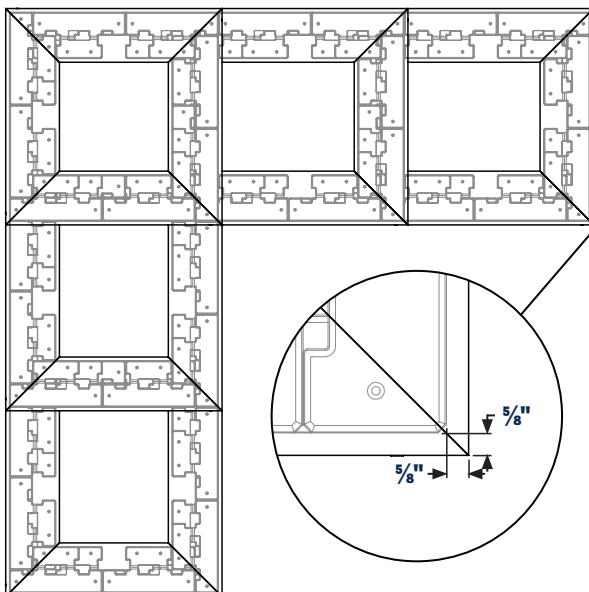

Do not forget to add glue in the cavities before laying down the frames.