



BELGARD®
PAVES THE WAY™

T-BLOCK



**SQUARE PLANTER
AND BENCH**

T-BLOCK

COMPLETE THIS STEP
FIRST FOR ALL PROJECTS

BASE PREPARATION

Always level ground before installation

ON NEW OR EXISTING PATIO

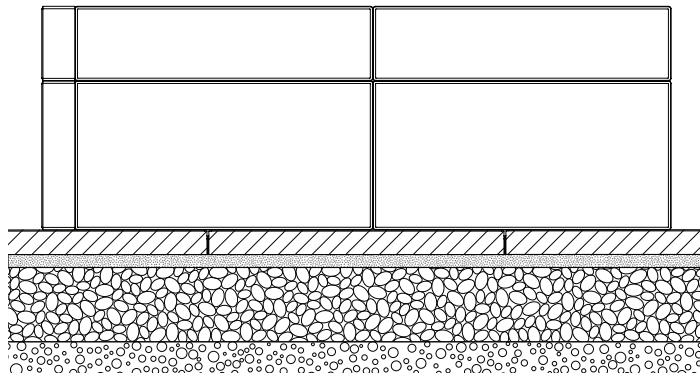

SLAB OR PAVER

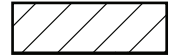

BEDDING SAND 1"

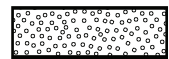

COMPACTED AGGREGATES 6"-8"



SOIL

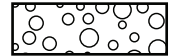

ON POURED CONCRETE

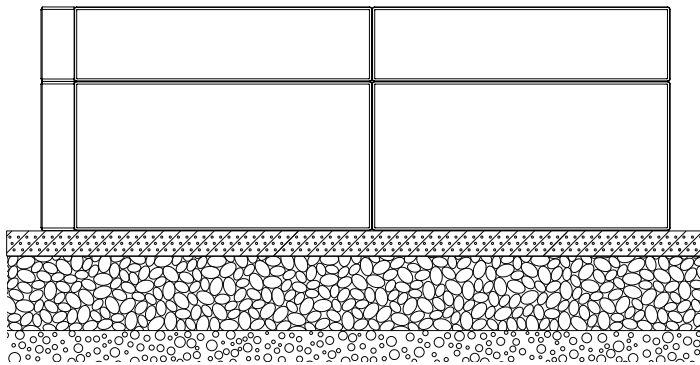

REINFORCED POURED CONCRETE FOUNDATION 2"

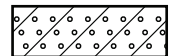

COMPACTED AGGREGATES 6"-8"



SOIL



ON COMPACTED FOUNDATION

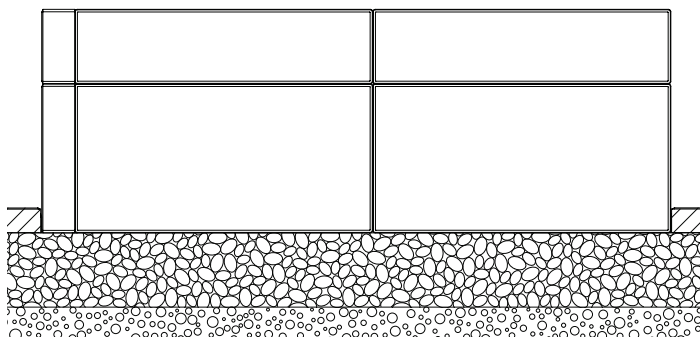

SLAB OR PAVER



COMPACTED AGGREGATES 6"-8"



SOIL

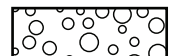

T-BLOCK

SQUARE PLANTER AND BENCH

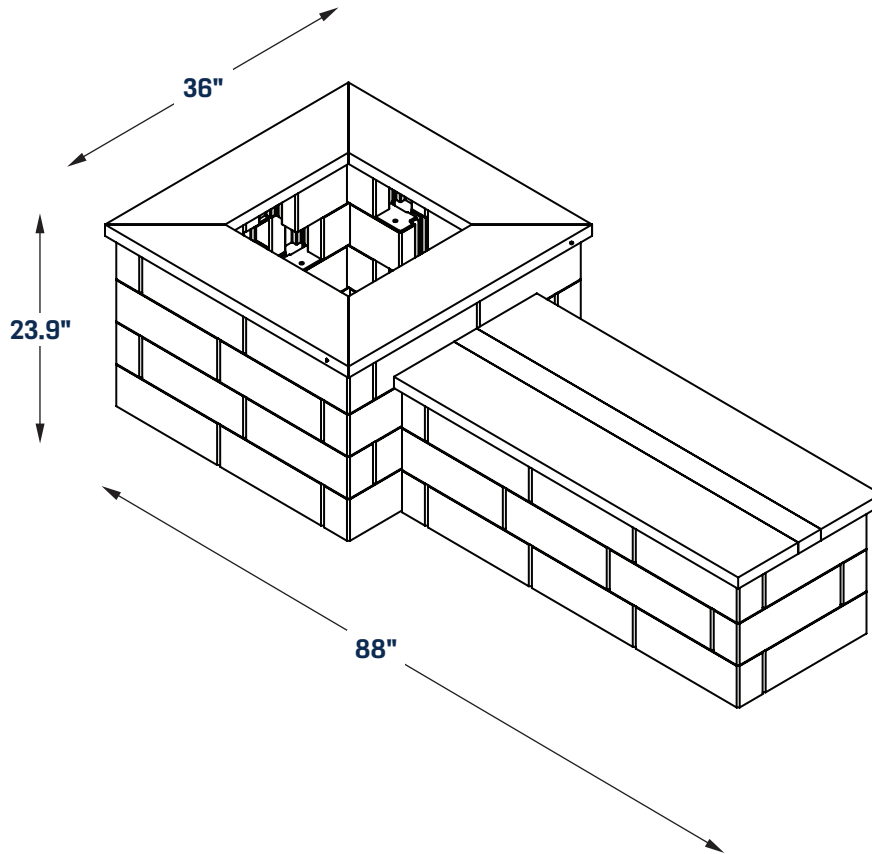

COMPONENTS

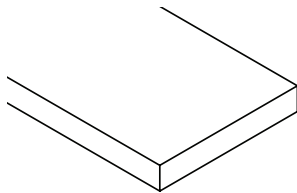

2" x 10" x 8' (x3)

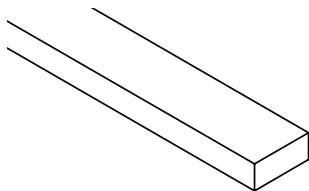

2" x 4" x 8' (x1)

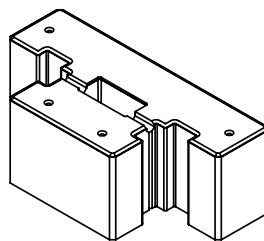

T-Block (x56)



Glue Tube



No.8 x 2½" (x12)



No.8 x 3" (x4)

T-BLOCK

SQUARE PLANTER AND BENCH

REQUIRED TOOLS

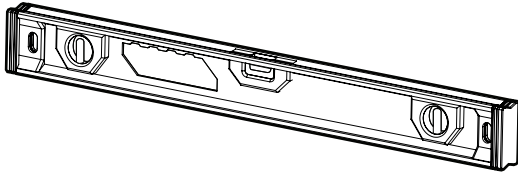

LEVEL

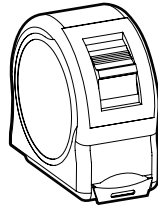

**MEASURING
TAPE**

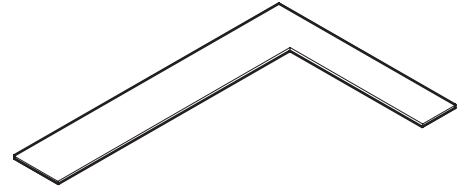

**CARPENTER
SQUARE**

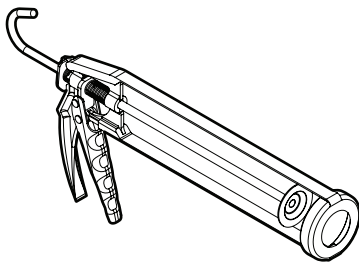

**SILICONE
GUN**

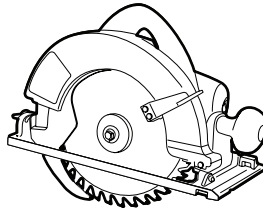

SKILSAW

SAFETY EQUIPMENT



SAFETY BOOTS

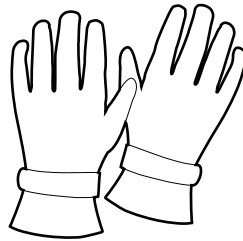

GLOVES

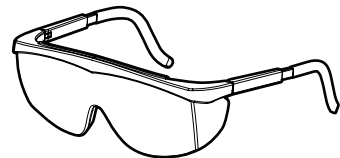

SAFETY GLASSES

T-BLOCK

SQUARE PLANTER AND BENCH

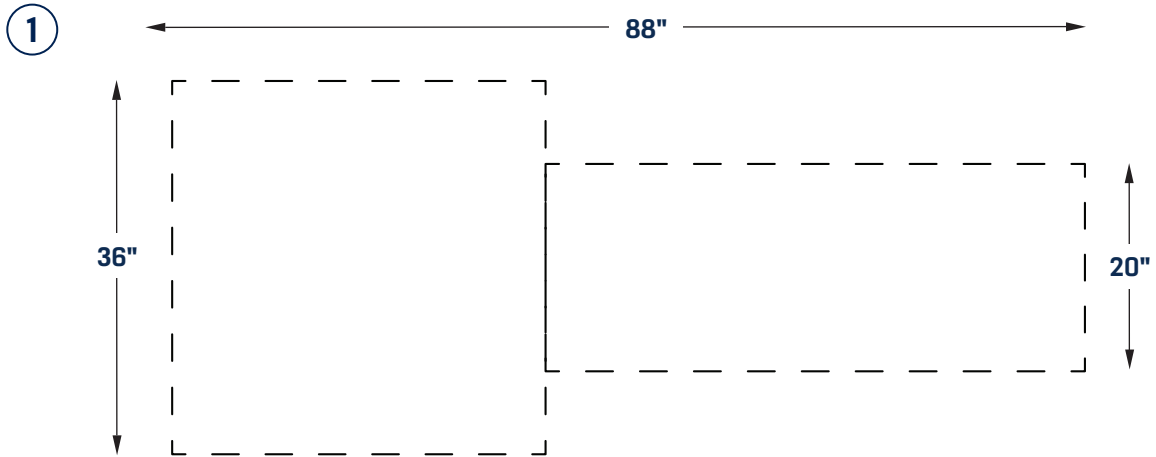

- ② Do not forget to add glue in the cavities before laying down your next level.

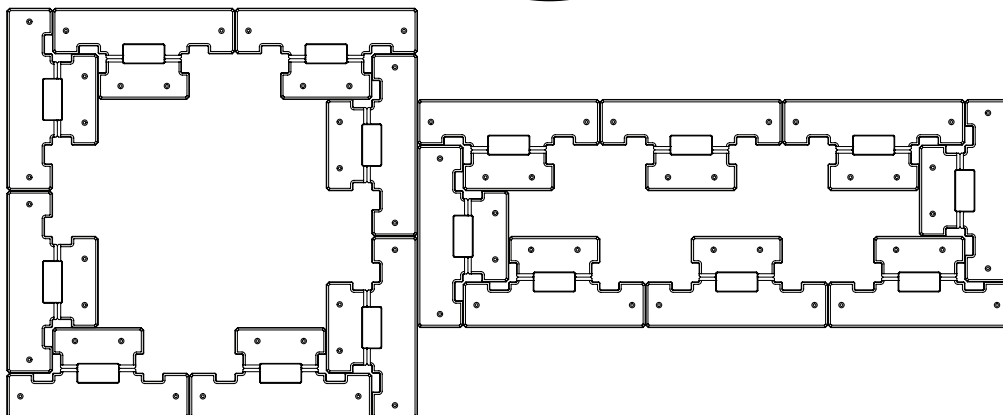
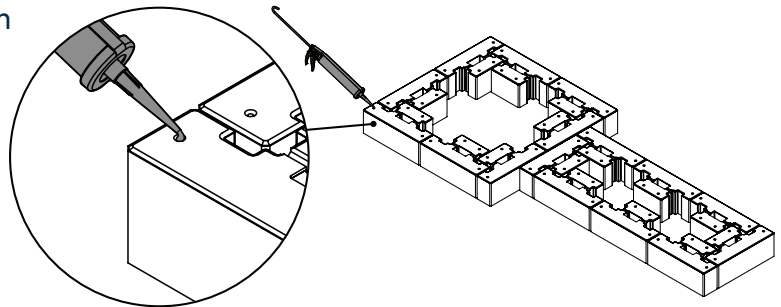

T-BLOCK

SQUARE PLANTER AND BENCH

- 3 Do not forget to add glue in the cavities before laying down your next level.

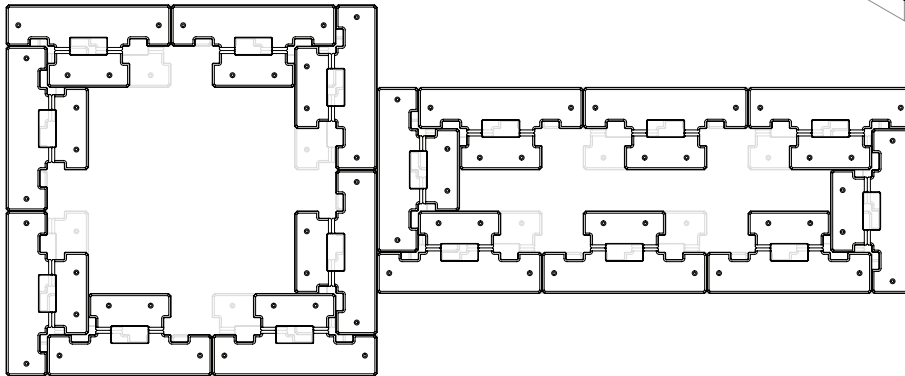
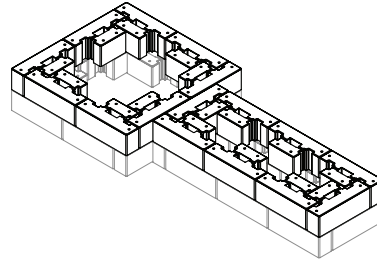

- 4 Do not forget to add glue in the cavities before laying down your next level.

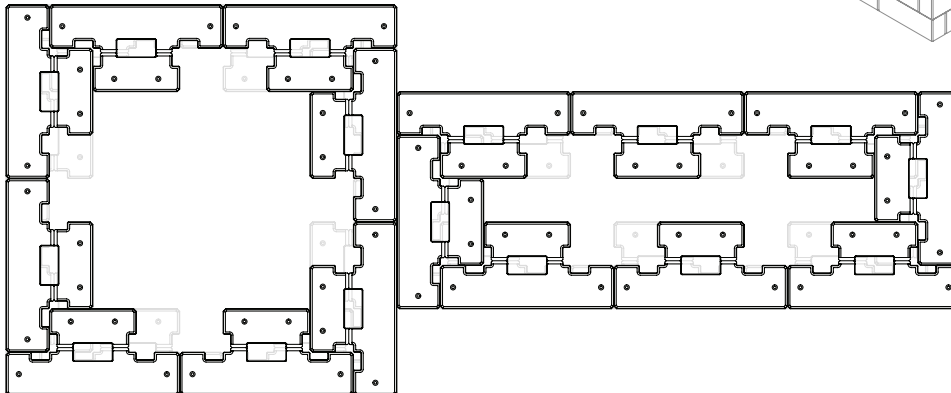
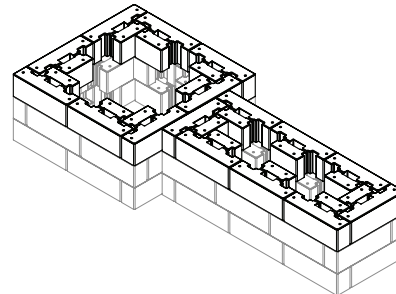

T-BLOCK

SQUARE PLANTER AND BENCH

- 5 Do not forget to add glue in the cavities before laying down your next level.

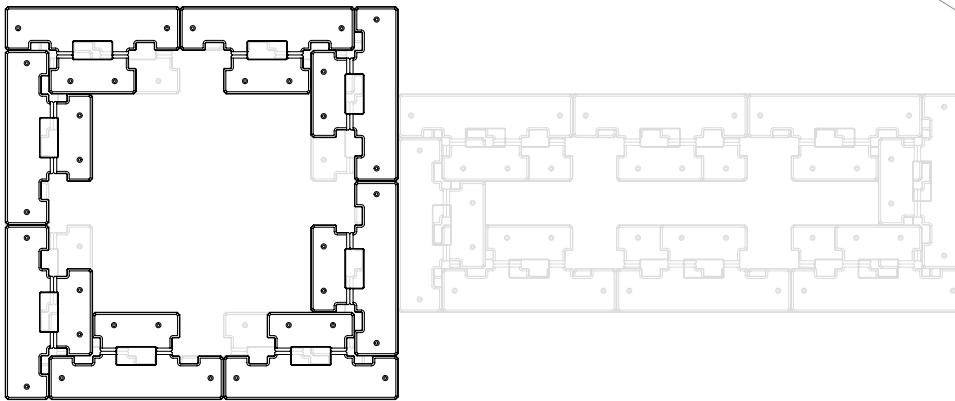
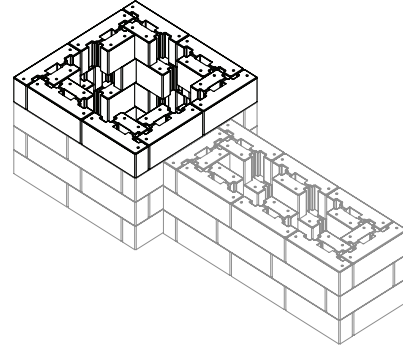

WOOD CUTS

- 2" x 4" x 8' A = 53"
- 2" x 10" x 8' B = 11³/₄"
- C = 53"
- D = 37¹/₄"

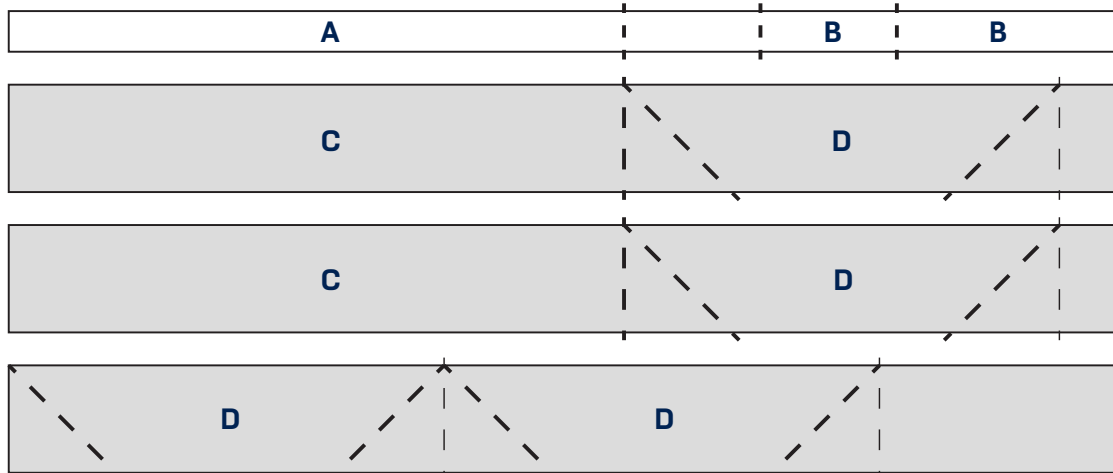
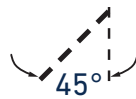

T-BLOCK

SQUARE PLANTER AND BENCH

6

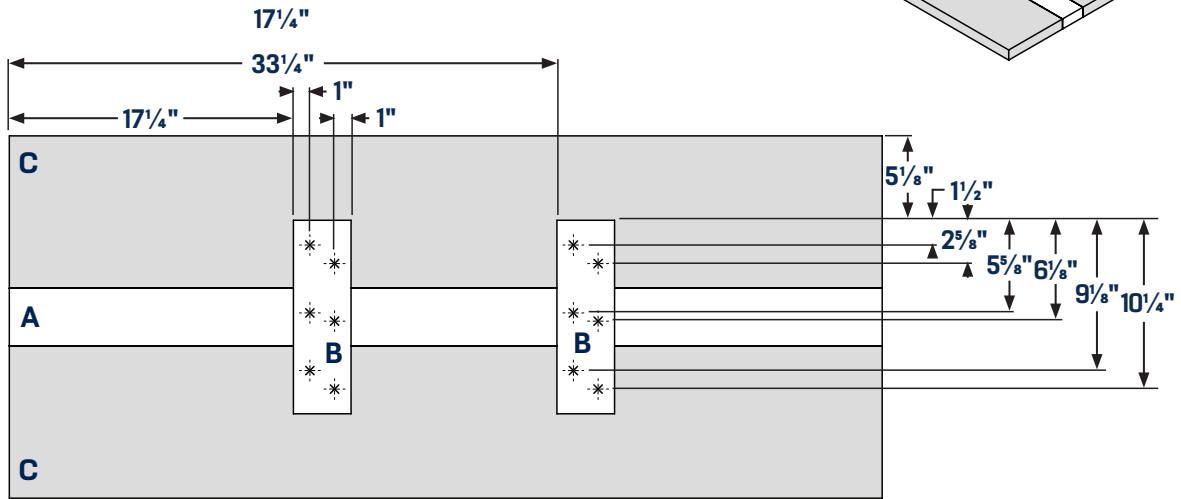
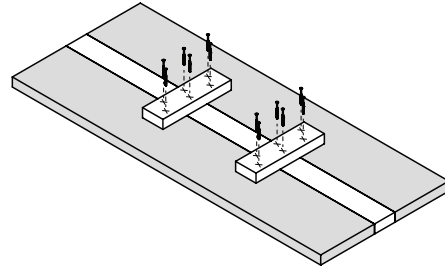

7

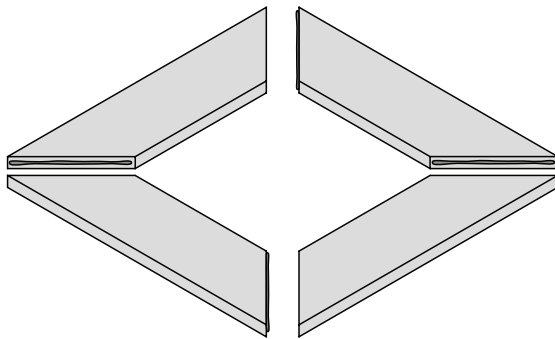
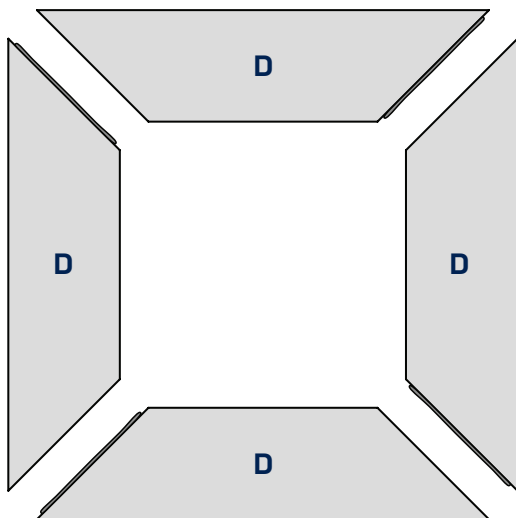

Put the angle pieces together to create the frame shape, keeping all edges aligned while the glue sets.

T-BLOCK

SQUARE PLANTER AND BENCH

8

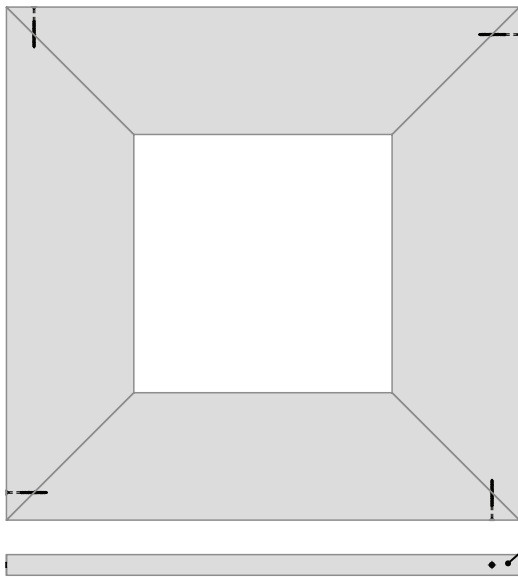

Add the screws (3") in each corner, making sure they go through the middle of the boards for a solid connection.

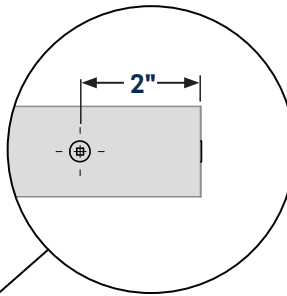

9

Do not forget to add glue in the cavities before laying down the frame and seat.

