



BELGARD®  
PAVES THE WAY™

# T-BLOCK



**44" SQUARE PLANTER**

# T-BLOCK

COMPLETE THIS STEP  
FIRST FOR ALL PROJECTS

## BASE PREPARATION

Always level ground before installation

### ON NEW OR EXISTING PATIO

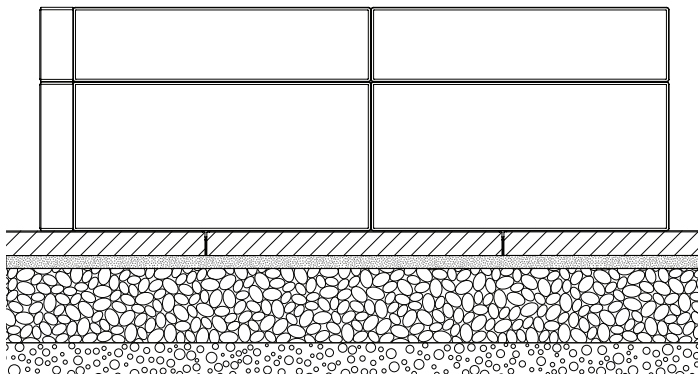

### SLAB OR PAVER



### BEDDING SAND 1"

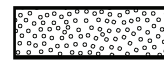

### COMPACTED AGGREGATES 6"-8"

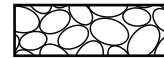

### SOIL

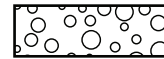

### ON POURED CONCRETE

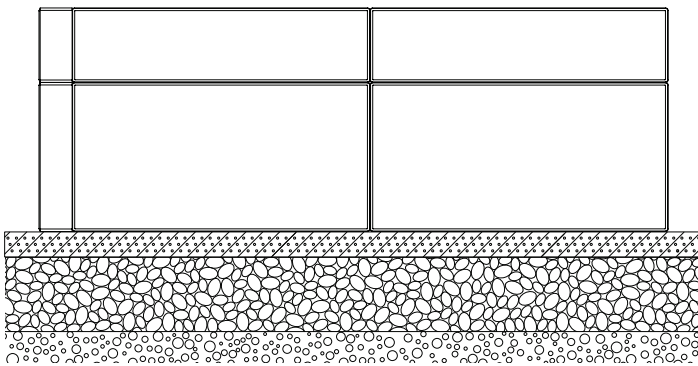

### REINFORCED POURED CONCRETE FOUNDATION 2"

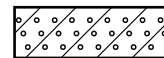

### COMPACTED AGGREGATES 6"-8"



### SOIL

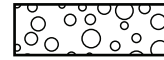

### ON COMPACTED FOUNDATION

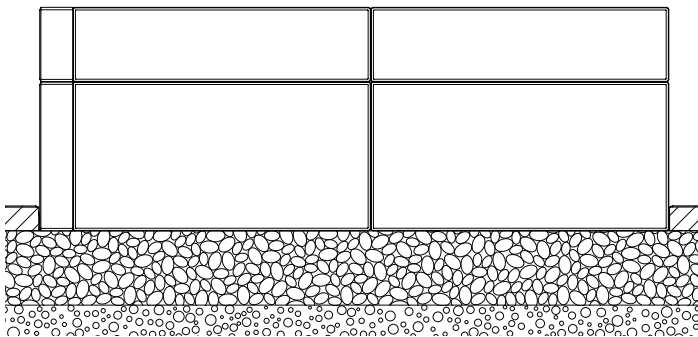

### SLAB OR PAVER

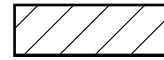

### COMPACTED AGGREGATES 6"-8"



### SOIL

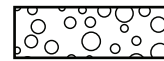

# T-BLOCK

44" SQUARE  
PLANTER

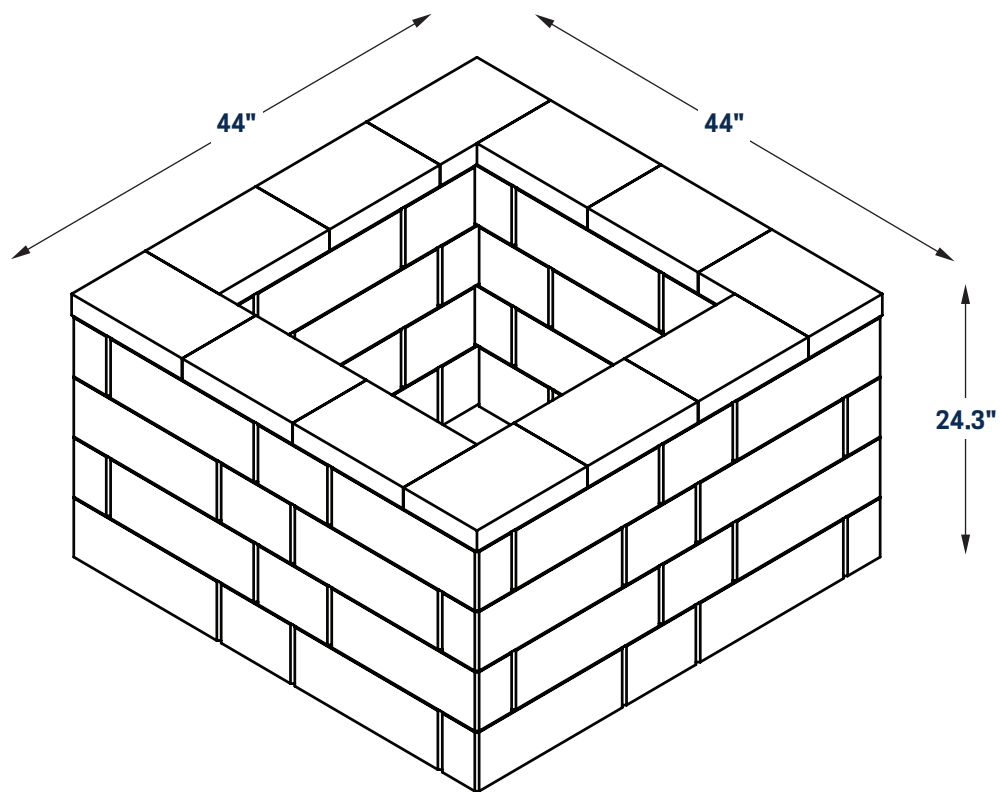

## COMPONENTS

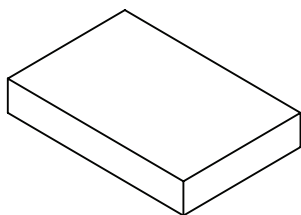

Cap (x12)

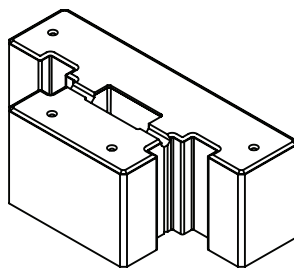

T-Block (x48)



Glue Tube

# T-BLOCK

44" SQUARE  
PLANTER

## REQUIRED TOOLS

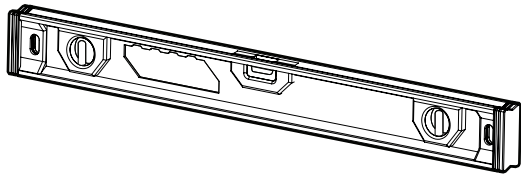

LEVEL

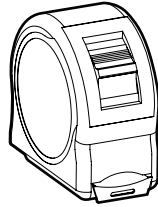

MEASURING  
TAPE

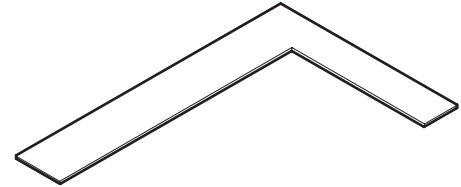

CARPENTER  
SQUARE

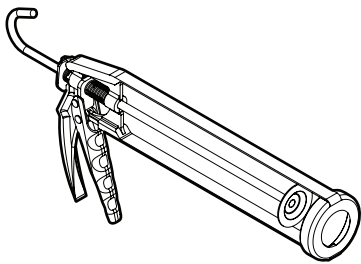

SILICONE  
GUN

## SAFETY EQUIPMENT



SAFETY BOOTS

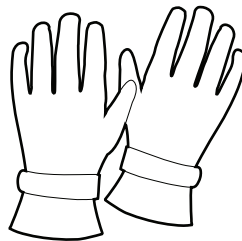

GLOVES

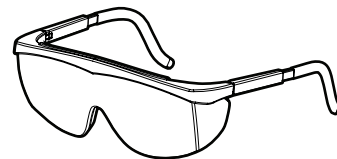

SAFETY GLASSES

# T-BLOCK

## 44" SQUARE PLANTER

①

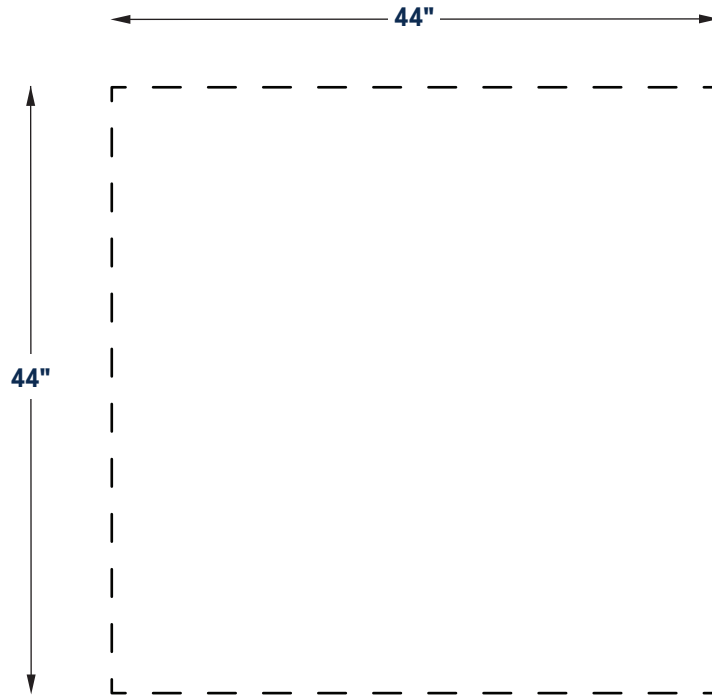

②

Do not forget to add glue in the cavities before laying down your next level.

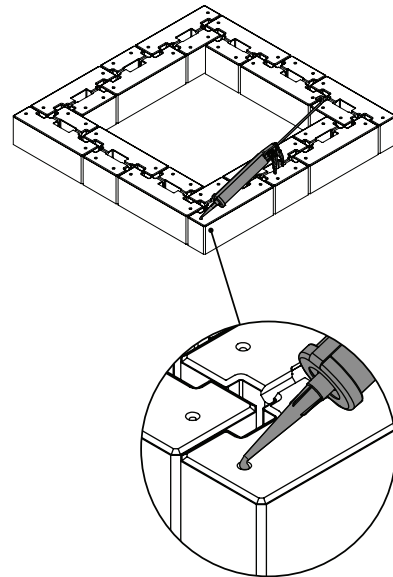
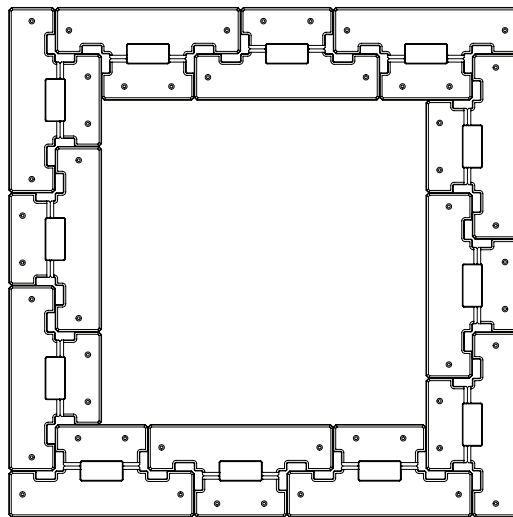

# T-BLOCK

## 44" SQUARE PLANTER

- 3** Do not forget to add glue in the cavities before laying down your next level.

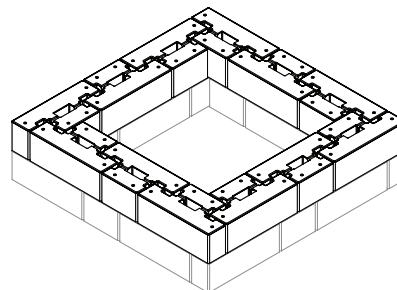
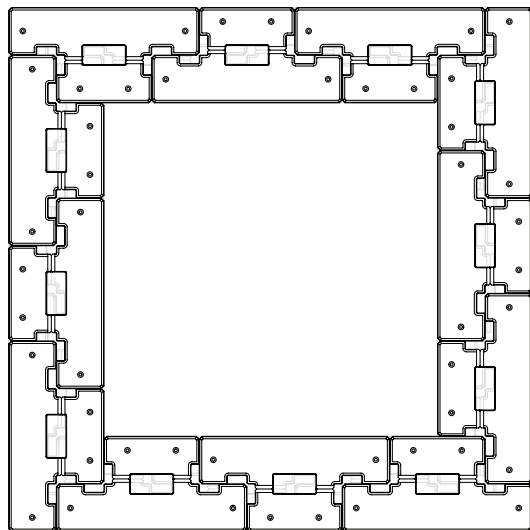

- 4** Continue alternating steps 2 and 3 until you have 4 levels (2 of each). Don't forget to add glue in the cavities before each new level.

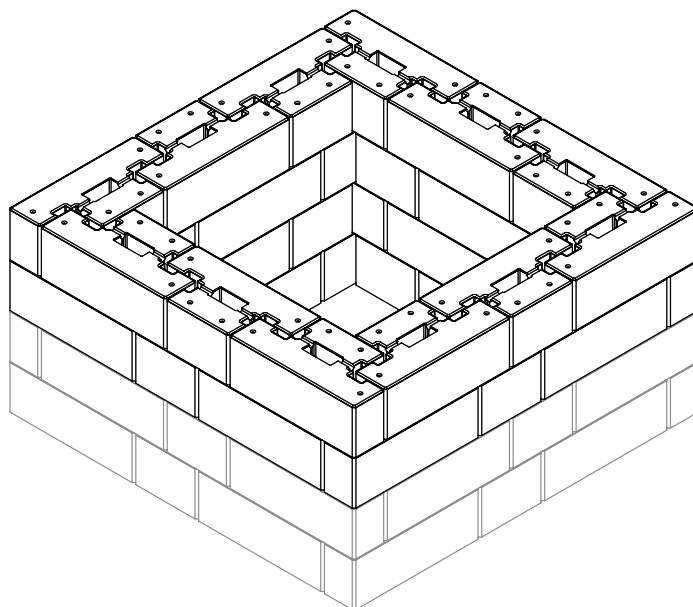

# T-BLOCK

## 44" SQUARE PLANTER

- 5 Do not forget to add glue in the cavities before laying down your next level.

