

BELGARD®

Rooftop Product Portfolio



WHY PROS CHOOSE BELGARD

QUALITY

Belgard pavers and rooftop systems are engineered for long-term performance and beauty to reduce call-backs. Every product is backed by rigorous standards to ensure confidence in every installation.

SERVICE

Belgard and the Oldcastle APG family of brands deliver national scale with local manufacturing, distribution and field support. With more than 150 locations, we help keep product available, projects on schedule and jobsites supplied.

EXPERTISE

For over 25 years, Belgard has led the industry with proven installation standards and training. Our Belgard Authorized Contractors and certified installers are backed with technical support and resources from takeoff to final walkthrough.

INNOVATION

Belgard invests over 20,000 R&D hours each year to develop new systems, textures and installation solutions that help you work faster and build better spaces. Our products set performance standards and keep your offering ahead of trends.

DESIGN

Belgard design tools, pattern libraries and visualization resources help you show customers what's possible and sell more complete rooftop projects. From simple patios to complex multi-level spaces, our portfolio supports your client's vision.

TABLE OF CONTENTS

Concrete & Wood Products — PAGES 04 - 13

- 06 Delta (Texada) Plaza Slab
- 07 Jewell Plaza Slab
- 08 Classic Plaza Slab
- 10 Pedslab®
- 11 Ballast Pavers
- 12 Wood Plaza Pavers
- 13 Cubes & Cube Tops

Porcelain — PAGES 14 - 19

- 16 Glocal
- 17 Noon
- 18 Quarziti 2.0

Product Details — PAGES 20 - 25

Accessories — PAGES 26 - 31

- 28 Adjustable Pedestals
- 29 Fixed Height
- 30 Prime Pedestal
- 31 Screwjack

Installation & Layout Assistance — PAGES 32 - 35

Reference Information — PAGES 36 - 39





**CONCRETE &
WOOD PRODUCTS**

DELTA (TEXADA) PLAZA SLAB

Concrete Slab | Western US & Canada

Available in shotblast finish, these slabs are made from a high-density concrete suited for use on grade or pedestals in commercial or residential projects. In rooftop applications, plaza slabs can be elevated on high-density polypropylene pedestals, which provide uniform spacing and draining and can achieve a dead-level installation, if desired.



AVAILABLE COLORS

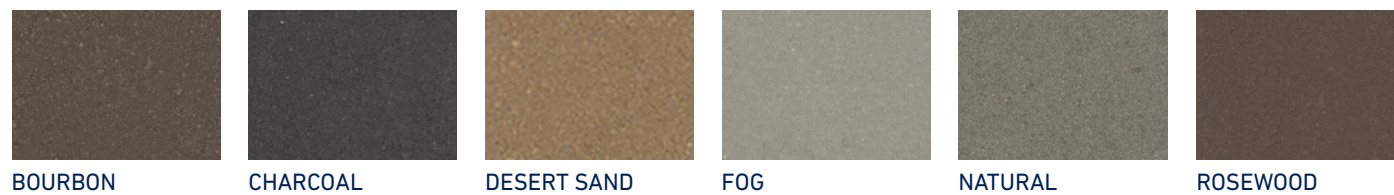

TECHNICAL SPECS

DIMENSIONS	WEIGHT	DIMENSIONAL TOLERANCE	WATER ABSORPTION	POINT LOAD	FREEZE THAW
18" x 18" x 1 ¹³ / ₁₆ "** 12" x 24" x 1 ¹³ / ₁₆ "** 24" x 24" x 1 ¹³ / ₁₆ "	23 lbs. per square foot	+/- 1/8" (length, width, height, convex, concave)	5% - ASTM C140	2,000 lbs.	1% loss of dry weight - ASTM Test Method C67

**Special Order - Inquire for Availability

JEWELL PLAZA SLAB

Concrete Slab | Southern US

These slabs feature a contemporary smooth finish and are ideal for pedestal set applications. Their large size makes them perfect for plazas and rooftop systems, while also providing a durable surface designed to withstand pedestrian traffic.



AVAILABLE COLORS



TECHNICAL SPECS

DIMENSIONS	WEIGHT	QTY/PALLET	PALLET WEIGHT	WATER ABSORPTION	POINT LOAD	FREEZE THAW
23 1/2" x 23 1/2" x 2" nominal	24 lbs. per square foot	22 units	2,225 lbs.	5% per ASTM C140	2,000 lbs.	1% loss of dry weight per ASTM C67

CLASSIC PLAZA SLAB

Concrete Slab | Eastern US

Classic Plaza Slabs are a high-density concrete suited for use as a plaza deck component providing a durable, yet elegant, roof surface. Plaza slabs are elevated on high-density polypropylene pedestals, which provide uniform spacing and draining and can achieve a dead-level installation, if desired.



TECHNICAL SPECS

DIMENSIONS	WEIGHT	DIMENSIONAL TOLERANCE	WATER ABSORPTION	POINT LOAD	FREEZE THAW
24" x 24" x 1 7/8" nominal	23 lbs. per square foot	+/- 1/8" (length, width, height, convex, concave)	Less than 5%	2,000 lbs.	Less than 1% loss in weight after 40 cycles

Do not use de-icing agents including but not limited to Ammonium Nitrate, Ammonium Sulfate, Sodium Chloride (Salt) and Calcium Chloride; these agents are destructive to concrete pavers. During the course of the work and on completion, remove any cutting dust from the surface of the pavers by means of water or air. If left unattended, cut dust can and will discolor pavers. When cleaning with high pressure water, use caution to avoid damage to slabs. Refer to the Plaza Paver Specifications for more information, which is available for download on BelgardCommercial.com.

AVAILABLE COLORS

SHOT BLAST



CHAMOIS CHARCOAL CINNAMON GINGER LIMESTONE NATURAL



RED SRI WHITE*

DIAMOND

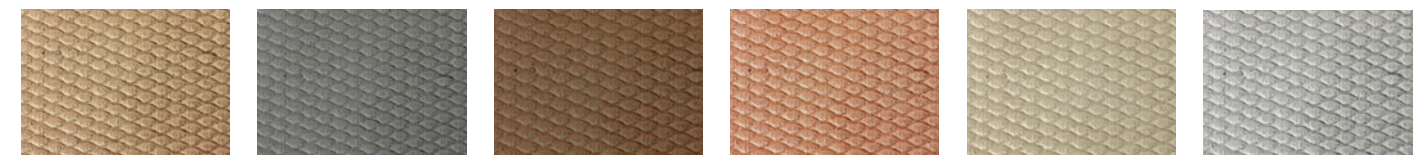

CHAMOIS CHARCOAL CINNAMON GINGER LIMESTONE NATURAL

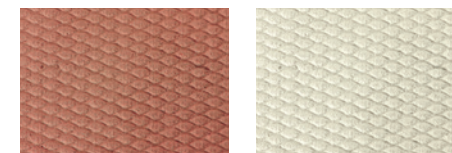

RED SRI WHITE*

MATTE



CHAMOIS CHARCOAL CINNAMON GINGER LIMESTONE NATURAL



RED SRI WHITE*

* SRI Color - Solar Reflective Index in Excess of 80. Contact your local Belgard® representative for more information.

PEDSLAB®

Concrete Slab

The PedSlab built-in pedestal system is designed to reduce installation labor. The corner pieces allow traditional methods of shimming or leveling, and pedestal edges are relieved to reduce the chance of membrane damage. The 9-pedestal layout gives the PedSlab Pedestal System its unique system.

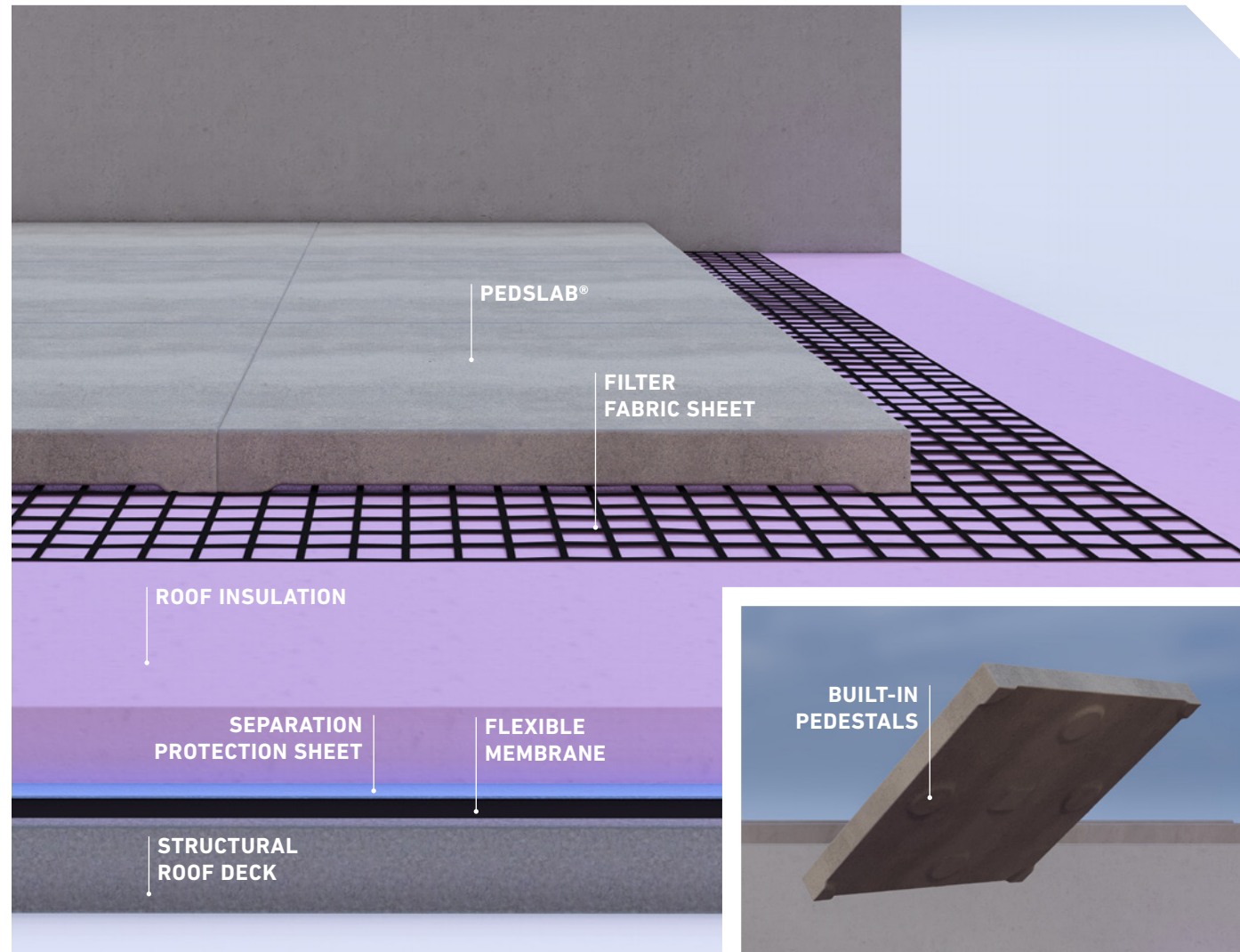

TECHNICAL SPECS

DIMENSIONS	WEIGHT	WATER ABSORPTION	POINT LOAD	FREEZE THAW
24" x 24" x 2 1/4" nominal Pedestal height: 3/8" with 50% of bearing area	28.75 lbs. per square foot	Less than 5%	2,000 lbs.	Less than 1% loss in weight after 40 cycles

BALLAST PAVERS

Concrete Paver

Ballast Rooftop Pavers are designed to prevent uplift from high winds. These high-density concrete pavers provide a consistent, evenly distributed weight from wind uplift and damage. Additionally, Ballast Pavers also protect the roof system from UV degradation, thermal shock and impact from hail or other falling objects.



TECHNICAL SPECS

DIMENSIONS	WEIGHT	DIMENSIONAL TOLERANCE	WATER ABSORPTION	FREEZE THAW
8 1/2" x 16" x 1 1/2" nominal	13.75 per square foot	+/- 1/8" (length, width, height, convex, concave)	Less than 5%	Less than 1% loss in weight after 40 cycles

Do not use de-icing agents including but not limited to Ammonium Nitrate, Ammonium Sulfate, Sodium Chloride (Salt) and Calcium Chloride; these agents are destructive to concrete pavers. During the course of the work and on completion, remove any cutting dust from the surface of the pavers by means of high pressure water or air. If left unattended, cut dust can and will discolor pavers. When cleaning with high pressure water, use caution to avoid damage to pavers. Refer to the Ballast Paver Specification for more information, which is available for download on BelgardCommercial.com.

WOOD PLAZA PAVERS

Wood Paver

Wood Plaza Pavers are untreated, low-maintenance tiles made from durable hardwoods such as Cumaru, Bamboo, Itauba, Tigerwood, or Ipe. Known for their density, strength, and resistance to decay and insects, these woods naturally develop a faded, aged patina over time, depending on climate. Tile ends are factory-sealed with wax to help prevent splitting. Any field cuts should also be sealed. Wax may be visible initially but will fade with time.



AVAILABLE COLORS



CUMARU

GARAPA

ITAUBA

IPE

TIGERWOOD

TECHNICAL SPECS

DIMENSIONS	WEIGHT	SURFACE	FIRE RATING	COLOR	JANKA HARDNESS RATING
23 ⁷ / ₈ " x 23 ⁷ / ₈ " x 1.69" nominal 23 ⁷ / ₈ " x 47 ⁷ / ₈ " x 1.69" nominal	4-6 lbs per square foot based on species of wood	Smooth	Class A (ASTM E 108-07a Spread of Flame)	Brown (natural variations to be expected)	Ipe = 3,680 lbf Cumaru = 3,540 lbf Garapa = 1,630 lbs Itauba = 2,274 lbs Tigerwood = 2,170 lbs

FSC® Certified Available (FSC-C131838)
Cleaning, Sealing, Staining: If desired, Wood Pavers can be periodically cleaned, stained and sealed. Before applying any finish, first clean and remove any residue or excess wax from the wood paver. The following manufacturers offer products specifically designed for use with tropical hardwoods: Cabots, Penofin, Messmers.

CUBES & CUBE TOPS

Cubes

These popular powder-coated aluminum and Ipe wood cubes provide a great way to add accents to commercial plazas. Each powder-coated aluminum or Ipe wood cube can be used as a stand-alone accent, as a planter, or combined for a multidimensional look. Made of 100% natural wood, the Ipe cubes are eco-friendly and resistant to mold, fire, weather and pests. Cube tops can be added to create bench seating and storage.



TECHNICAL SPECS

POWDER-COATED ALUMINUM CUBES		IPE WOOD CUBES	
COMMON DIMENSIONS	MATERIAL	COMMON DIMENSIONS	MATERIAL
24" L x 24" W x 20" H 24" L x 24" W x 36" H 48" L x 24" W x 20" H 48" L x 24" W x 36" H	Recycled raw material content (40% minimum)	24" L x 24" W x 16 ¹ / ₂ " H 48" L x 24" W x 16 ¹ / ₂ " H	Hardwood harvested sustainably from Brazilian Forests

All Cubes and Tops are made to order.
Custom sizes and colors are available. Contact your Westile representative for more information.



PORCELAIN

GLOCAL

Concrete Finish | 20mm

The smooth concrete-like finish offers a clean, contemporary aesthetic. Its structured and tight surface texture in neutral shades makes this porcelain paver a versatile design element.



- v2** SLIGHT SHADE VARIATION
- LOW SOLAR HEAT ABSORPTION
- ACCESSIBLE SURFACE

PALLET INFORMATION

GLOCAL		SQFT/ PALLET	SQFT/ BOX	BOXES/ PALLET	PCS/ BOX	WEIGHT/ BOX	WEIGHT/ PALLET
24 X 24	23.54 x 23.54 x 3/4	248	7.75	30	2	72	2160
24 X 48	23.54 x 47.17 x 3/4	271.25	7.75	35	1	74	2621
48 X 48	47.17 x 47.17 x 3/4	310	15.5	20	1	148.5	3009

SHAPES & SIZES

- 24 X 24
 23.54 x 23.54 x 3/4
- 24 X 48
 23.54 x 47.17 x 3/4
- 48 X 48
 47.17 x 47.17 x 3/4

NOON

Wood Finish | 20mm

Warm and stylish, this contemporary expression of simplicity combines the look and feel of natural wood with the durability of porcelain.



- v3** MODERATE SHADE VARIATION
- v4** HIGH SHADE VARIATION
- ACCESSIBLE SURFACE

PALLET INFORMATION

NOON		SQFT/ PALLET	SQFT/ BOX	BOXES/ PALLET	PCS/ BOX	WEIGHT/ BOX	WEIGHT/ PALLET
12 X 48	11.73 x 47.17	279	7.75	36	2	74	2664

SHAPES & SIZES

- 12 X 48
 11.73 x 47.17

QUARZITI 2.0

Stone Finish | 20mm

This interpretation of natural quartz incorporates a gentle shading effect with the authentic diversity and subtle iridescence of natural elements.



MIRAGE
INSPIRING BETTER LIVING

v3 MODERATE SHADE VARIATION

LOW SOLAR HEAT ABSORPTION

ACCESSIBLE SURFACE

PALLET INFORMATION

	QUARZITI 2.0	SQFT/PALLET	SQFT/BOX	BOXES/PALLET	PCS/BOX	WEIGHT/BOX	WEIGHT/PALLET
24 X 24	23.54 x 23.54 x 3/4"	248	7.75	30	2	72	2160
24 X 48	23.54 x 47.17 x 3/4"	271.25	7.75	35	1	74	2621

SHAPES & SIZES

24 X 24
 23.54 x 23.54 x 3/4"

24 X 48
 23.54 x 47.17 x 3/4"

NOTE: For rooftop installation mesh backing is required. Contact your Belgard Representative for information.

BENEFITS OF PORCELAIN PAVERS

- **ARCHITECTURAL VERSATILITY** - Elegant styles and finishes for use with pedestal, adhered or paver base installations.
- **PROVEN PERFORMANCE** - Engineered for demanding rooftop and plaza environments.
- **LOW MAINTENANCE** - Dense surfaces simplify cleaning and long-term upkeep.
- **MODULAR FLEXIBILITY** - Precision sizing supports efficient installation and future access.

RESISTANT



TO FREEZE-THAW
 100% frost-free and stable from -60°F to 140°F.



TO BREAKAGE
 Withstands breakage loads of more than 2,200 lbs.



TO CHEMICALS
 Resists alkalis, acids, salts, and deicing materials.



TO STAINS
 Ultra-low absorption resists stains, mold, moss, and dirt.

EASIER



TO LAY
 Consistent sizing and linear edges support fast, accurate layouts.



TO CLEAN
 Cleans easily with standard cleaners or pressure washing.



TO REMOVE
 A 24" x 24" paver weighs just 37 lbs. for easier removal and reuse.*



TO WALK ON
 Structured surface textures provide slip-resistant traction.

TECHNICAL SPECS

Standard Test Methods for Determination of Water Absorption	ASTM C373-18	Absorption = 0.0% per ASTM C373-18
Thermal Shock Resistance	ASTM C484-99 (2014)	Not affected by ASTM C484
Standard Test Method for Freeze-Thaw Cycling	ASTM C1026-13 (2018)	No visible damage
Resistance of Ceramic Tile to Chemical Substances	ASTM C650-20	Not affected
Crazing Resistance of Fired Glazed Whitewares by Autoclave Treatment	ASTM C424-93 (2016)	Not observed
Compressive Strength Testing is in accordance with ASTM C140	ANSI A137.3, Section 5.3.11	Higher than 30,000 psi
Determination of Breaking Strength and Modulus of Rupture	ASTM C1505	Breaking Load (P) lbf: 2,600 Breaking Strength lbf: 2,500 MOR psi: 6,000
Test Method for Evaluating Hard Body Impact Resistance	ANSI A137.3, Section 8.7	Passed at 18" pedestal support
Test method for Evaluating Soft Body Impact Resistance	ANSI A137.3, Section 8.6	Passed at 24" pedestal support
Determination of Resistance to Staining	ASTM C1378-20	Visual Test: "Not Affected"

* Excludes adhered installations.



**PRODUCT
DETAILS**

Plaza Rooftop Slabs & Pavers														
PRODUCT NAME	MATERIAL	PAVER THICKNESS (NOMINAL)	SIZE (NOMINAL)	APPLICATIONS					FINISHES				PIECES PER PALLET	SQ. FT. PER PALLET
				Pedestrian	Rooftops & Plazas	ADA	Roof Protection	Manual Installation	Standard/Smooth	Diamond	Matte	Shot Blast		
Classic Utility Slabs	Concrete	2"	24" x 24"	✓	✓	✓	✓	✓		✓	✓		25	100
Classic Plaza Slabs	Concrete	2"	24" x 24"	✓	✓	✓	✓	✓		✓	✓	✓	24	96
Classic Plaza Slabs	Concrete	2"	12" x 24"	✓	✓	✓	✓	✓		✓	✓	✓	48	96
Classic Plaza Slabs	Concrete	2"	24" x 36"	✓	✓	✓	✓	✓		✓	✓	✓	24	144
Delta (Texada) Plaza Slab	Concrete	1 13/16"	24" x 24"	✓	✓	✓	✓	✓				✓	25	100
Jewell Plaza Slabs	Concrete	2"	24" x 24"	✓	✓	✓	✓	✓	✓				22	88
Ballast Rooftop Pavers	Concrete	1.6"	8.5" x 16"				✓	✓	✓				200	189
Glocal	Porcelain	3/4"	23.54" x 23.54" 23.54" x 47.17" 47.17" x 47.17"	✓	✓	✓	✓	✓					60 35 20	232.5 271.25 310
Noon	Porcelain	3/4"	11.73" x 47.17"	✓	✓	✓	✓	✓					72	279
Quarziti 2.0	Porcelain	3/4"	23.54 x 23.54 23.54 x 47.17	✓	✓	✓	✓	✓					60 35	232.5 271.25
Ipe Wood Plaza Pavers	Wood	1.5"	24" x 24"	✓	✓	✓	✓	✓	✓				44	176
Ipe Wood Plaza Pavers	Wood	1.5"	24" x 48"	✓	✓	✓	✓	✓	✓				22	88
Cumaru Wood Plaza Pavers	Wood	1.5"	24" x 24"	✓	✓	✓	✓	✓	✓				44	176
Cumaru Wood Plaza Pavers	Wood	1.5"	24" x 48"	✓	✓	✓	✓	✓	✓				22	88
Eco-Ipe Wood Plaza Pavers	Wood	1.5"	24" x 48"	✓	✓	✓	✓	✓	✓				22	88

Notice: Check with your Belgard Commercial Representative for product availability.

Modular Benches & Cubes			
PRODUCT NAME	COMMON SIZES (CUSTOM SIZES AVAILABLE)	COLORS (CUSTOM COLORS AVAILABLE)	MINIMUM QTY
Powder-Coated Aluminum Cube	24"L x 24"W x 20"H	Red, Black, White, Charcoal, Silver	1
Powder-Coated Aluminum Cube	24"L x 24"W x 36"H	Red, Black, White, Charcoal, Silver	1
Powder-Coated Aluminum Cube	48"L x 24"W x 20"H	Red, Black, White, Charcoal, Silver	1
Powder-Coated Aluminum Cube	48"L x 24"W x 36"H	Red, Black, White, Charcoal, Silver	1
Ipe Cube	24"L x 24"W x 16.5"H	Brown (Natural variations occur)	1
Ipe Cube	48"L x 24"W x 16.5"H	Brown (Natural variations occur)	1
Ipe Top	24" x 24"	Brown (Natural variations occur)	1
Ipe Top	48" x 24"	Brown (Natural variations occur)	1

Notice: All cubes and tops are made to order.



Pedestals & Accessories		
PRODUCT NAME	PRODUCT DESCRIPTION	PIECES PER CARTON
STAR-T	3/8" - 9/16" (10-15mm)	50
STAR-B	3/16" Extension (5mm)	50
SE0-P	1.125" - 1.5" (28-38mm)	40
SE1-P	1.5" - 2" (37.5-50mm)	30
SE2-P	2" - 3" (50-75mm)	25
SE3-P	3" - 4.75" (75-120mm)	25
SE4-P	4.75" - 6.75" (120-170mm)	25
SE5-P	6.75" - 8.75" (170-215mm)	25
NM-1	1"-1.57" (25-40mm)	40
NM-2	1.57"-2.75" (40-70mm)	30
NM-3	2.36"-3.93" (60-100mm)	25
NM-4	3.54"-6.30" (90-160mm)	15
NM-5	5.90"-10.63" (150-270mm)	12
NM-EXT	5.7" Extension (145mm)	30
EH-12	1/2" Fixed (12mm)	250
EH-15	5/8" Fixed (16mm)	200
EH-20	3/4" Fixed (20mm)	150
RUB-14	1/4" Fixed RUBBER	150
RUB-38	3/8" Fixed RUBBER	150
RUB-PINS	1/4" Fixed w/ 4 Pins	100
PR1	1.2" - 2.55" Adjustable Pedestal	1 per box
PR2	6.1" Adjustable Pedestal	1 per box
PR3	16" Adjustable Pedestal	1 per box

Notice: Check with your Belgard Commercial Representative for product availability.



ACCESSORIES

ADJUSTABLE PEDESTALS

SE & NM Series



THE "KEY" TO YOUR SUCCESS

Our unique "Adjustment Key" allows you to level and adjust our Pedestal Supports WITHOUT removing the paver. This unique feature saves labor costs and reduces possible injuries from heavy pavers



LOCKING COUPLING

Allows head to be locked into the threaded screw.



BASE PRE-CUT LINES

Base bottom with pre-cut lines for easy and precise cuts when needed for corner placement situations.



BLOCK SYSTEM

Block system indicates to installer when unit has safely reached its maximum height adjustment. A cut out is also part of this system that allows the installer to push in a safety tab, releasing components if necessary.

- ✓ Paver installation system for unlevel surfaces or for allowing access to utilities.
- ✓ Bi-material head for increased stability and sound dampening
- ✓ Ability to raise and lower pedestals with pavers in place using adjustment key
- ✓ High load capacity
- ✓ Efficient installation



SE Support	
Self-Leveling Head	✓
Fixed	✓ With the Eterno Lock fixed locking piece only
Adjustable	✓
Extension Element	✓
Adjustment Key	✓
Locking IPE Pins	✓
Recyclable (LEED)	✓
Loading Capacity	2205 LBS. (1000 KG)
Height Range	1.125" - 21.75" (28 MM - 550 MM)

NM Support	
Self-Leveling Head	NA
Fixed	✓
Adjustable	✓
Extension Element	✓
Adjustment Key	✓
Locking IPE Pins	✓
Recyclable (LEED)	✓
Loading Capacity	3000 LBS. (1500 KG)
Height Range	1" - 10.63" (25 MM - 270 MM) 39" With Extensions

Features	Supports
#1 Bi-Material Head	New Self-Leveling Head with Bi-Material PP & Rubber Anti-Noise & Anti-Slip
#2 Pre-Cut Tabs	Easy removal of Tabs When Needed
#3 Locking Coupling	Coupling Locks into Head
#4 Block System	New Self-Leveling Head with Bi-Material PP & Rubber Anti-Noise & Anti-Slip
#5 Water Drainage Holes	No Ponding Water
#6 Adjustment Key	Levels Support without Removing Paver
#7 Screw	V0 3/4" (19mm) / V1 7/8" (22mm) / V2 1-1/4" (35mm) / V3 2-1/4" (60mm) / V4 4" (105mm) / V5 6" (155mm)
#8 Extension	Extension for Higher Requirements
#9 Base	B0 5/8" (16mm) / B1 7/8" (25mm) / B2 1-5/8" (40mm) / B3 2-1/2" (65mm)

Check with your local Belgard Representative for product availability.

FIXED HEIGHT

Pedestal Accessories



- ✓ Ideal for low height applications
- ✓ Stackable for more precise fit
- ✓ Facilitates fast water drainage to resist mold
- ✓ Absorbs expansion and structural movement

STAR T & EH SERIES

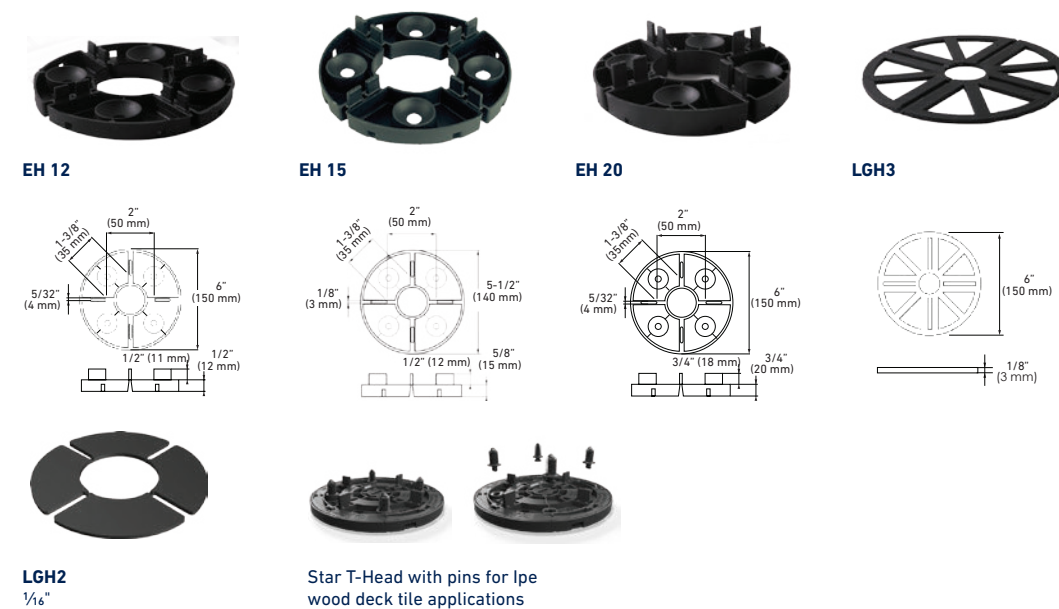

PRIME PEDESTAL

Adjustable Pedestal Systems



- ✓ Fully integrated system for rooftop paver installations
- ✓ Compatible with concrete, wood and porcelain pavers to improve rooftop performance or convert to usable space
- ✓ Ideal for uneven surfaces or slopes from 0 to 5%
- ✓ Integrated safety indicators to prevent over extension
- ✓ Three sizes for adjustable height from 1.18" to 16.53"
- ✓ Allows easy access to rooftop utilities
- ✓ Higher heights can be achieved with extension couplers

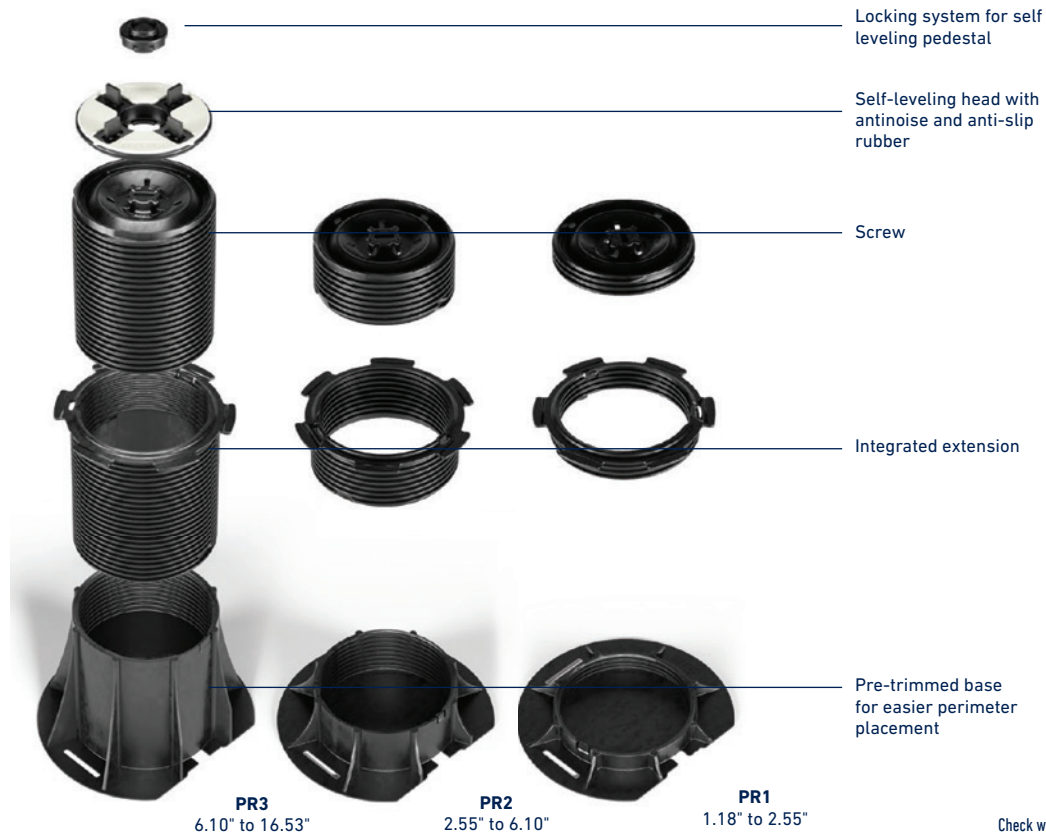

Check with your local Belgard Representative for product availability.

SCREWJACK

Adjustable Pedestals



- ✓ Improves commercial rooftop performance or convert into usable space
- ✓ Adjustable height range from 1/8" to 36"
- ✓ Easy screw-to-adjust functionality
- ✓ Speeds installation of wood and concrete pavers and slabs
- ✓ Allows future access to utilities and surface below
- ✓ Supports up to 1,000 lbs.
- ✓ Impervious to water, mold and freeze-thaw
- ✓ Contains 20% post-industrial recycled material

SCREWJACK ACCESSORIES



MODEL LD4
Provides 0"-1/4"
slope compensation



MODEL B11
Shim adds 1/16"
for fine
tune adjustment



MODEL PS1
Shim adds 1/8"
for fine
tune adjustment



MODEL HD25
Fixed 1/4" height with
3/16" spacer tab



MODEL HD50
Fixed 1/2" height with
3/16" spacer tab



MODEL HD75
Fixed 3/4" height with
3/16" spacer tab

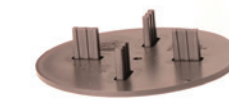

VT316
Ultra low height 3/16"
tab - 4 3/4" diameter

Check with your local Belgard Representative for product availability

SHAPES & SIZES

MODEL B1



Adjusts from 1 1/4"-2"
with 3/16" spacer tab

MODEL B2



Adjusts from 2"-3"
with 3/16" spacer tab

MODEL B3



Adjusts from 3"-4 3/4"
with 3/16" spacer tab

MODEL B4



Adjusts from 4 3/4"-7 3/4"
with 3/16" spacer tab

MODEL C4



Coupler adds 2 1/2"-4"
in height to B3 & B4

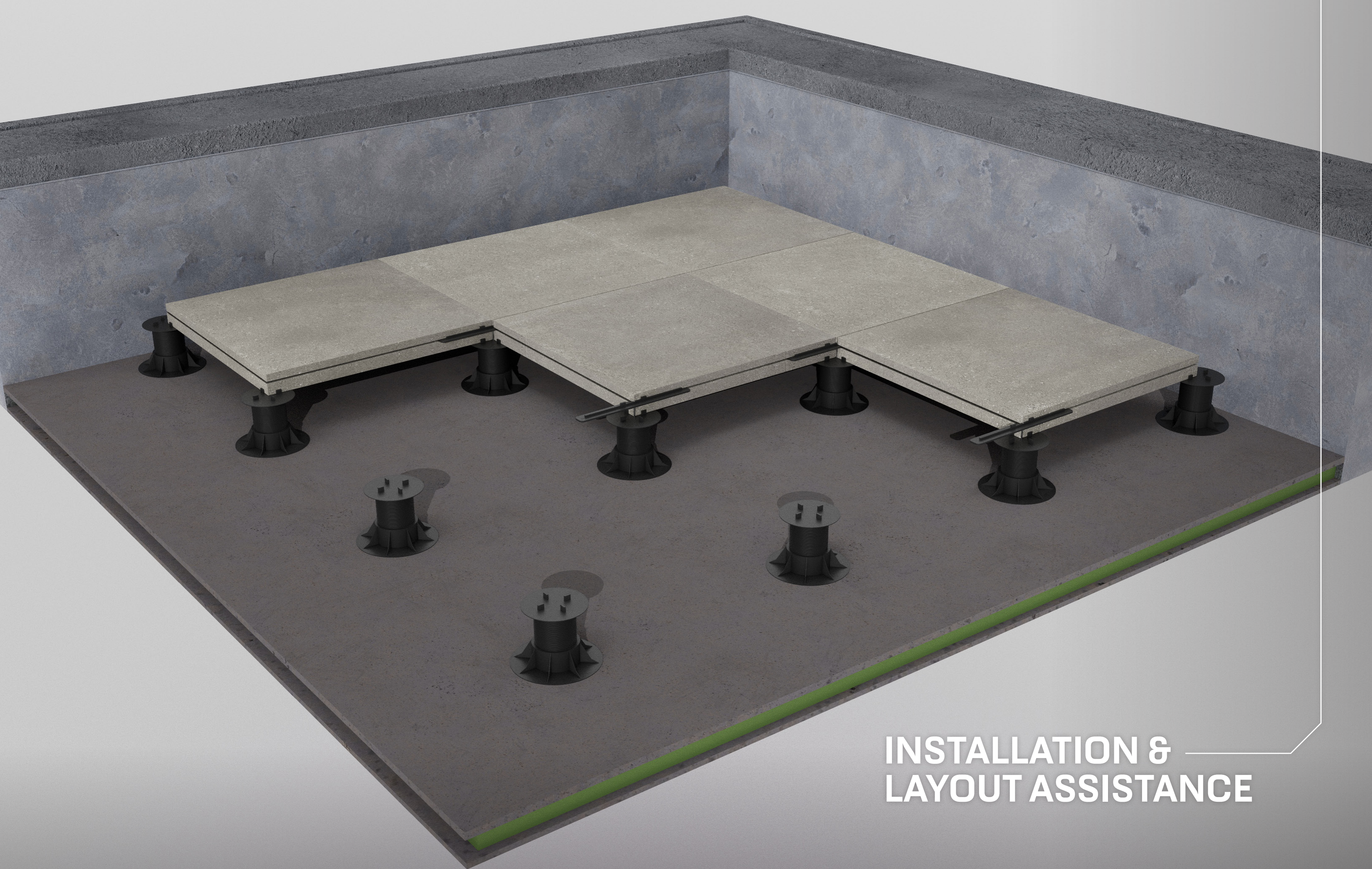

**INSTALLATION &
LAYOUT ASSISTANCE**

INSTALLATION INSTRUCTIONS

Level System

The Level System is used for a dead level paver surface. This system allows for installation of a level paver surface over various sloping substrates. This system is for conventional or IRMA Roof Assembly and for pedestrian use only.

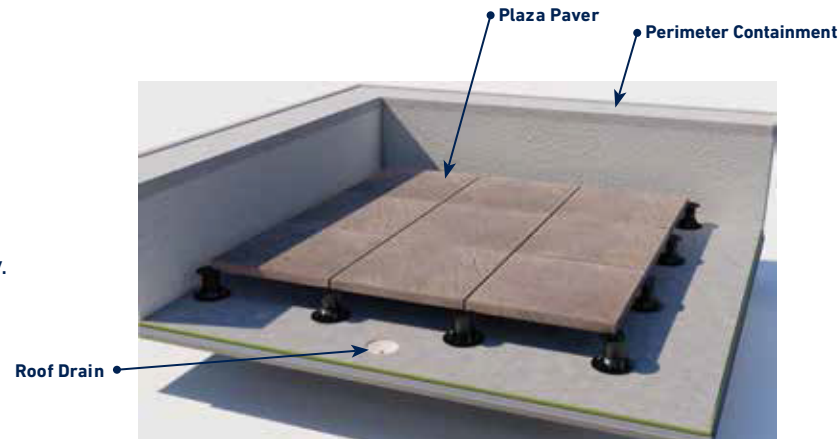

Sloped System

The Sloped System can be used when a dead level paver surface is not necessary. Pedestals are loose-laid and not attached to the roof assembly.

Pedestal Selection / Elevation

Installation requirements vary for each individual project site. Paver size, pattern, grid layout, starting point and finished deck surface elevation should be shown on shop drawings which have been approved by the designer, installing contractor and owner. Measurements from the construction site should be used for final pedestal selection and purchasing. The Finish Deck Surface Elevation is determined at the door threshold. The shortest pedestals are usually at the door threshold and the tallest are at the roof drains. To obtain pedestal height, subtract paver thickness from the Finish Deck Surface Elevation. If insulation is used, the insulation must have a minimum 40 psi compressive strength. Otherwise, a protection/recovery board is required.

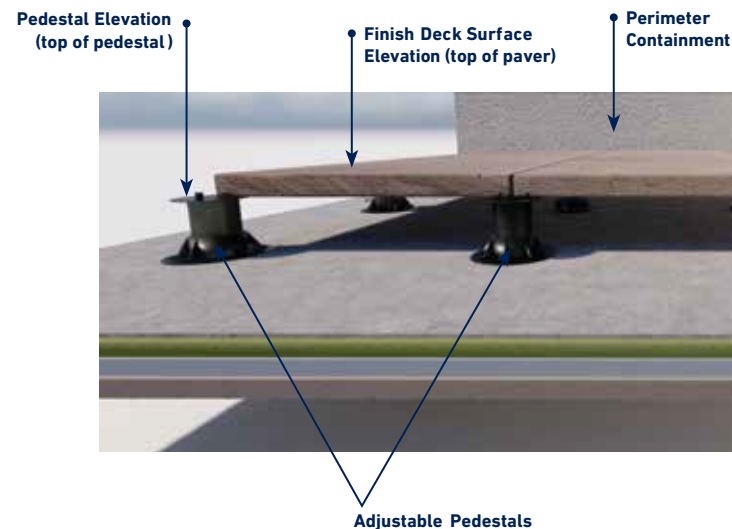
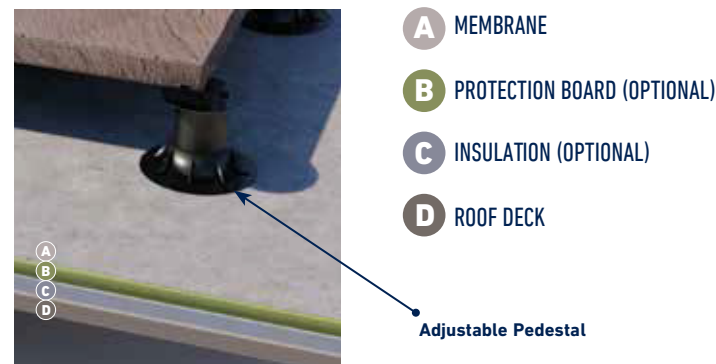

ROOFTOP PAVER LAYOUT SERVICE

We Can Help With Your Project

During the bid phase of a project, Belgard Commercial® can provide a rough component count based on square footage. This will include paver counts and pedestal counts. Once the project is awarded, a detailed layout (example 1) can be created showing more precise pedestal counts, heights and locations. This detailed layout takes approximately 5-7 business days to complete.

To create the detailed layout, the following information must be provided:

1. Paver type and size to be installed (i.e. Concrete, Wood or Porcelain; i.e. 24"x24")
2. Deck plan showing area (example 2)
3. Section detail (example 3)
4. Slope and drain locations (example 4)
5. Starting / threshold height (example 5)

EXAMPLE 1

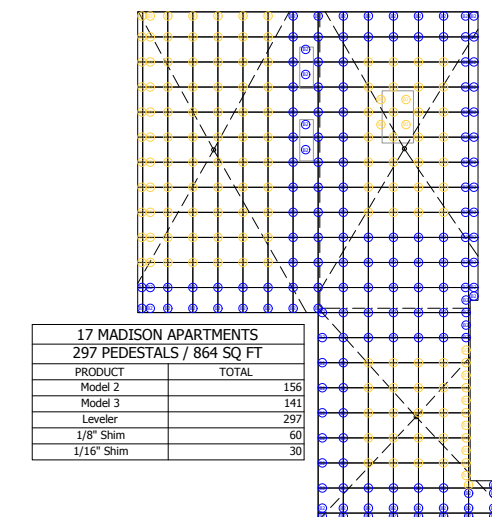

EXAMPLE 2

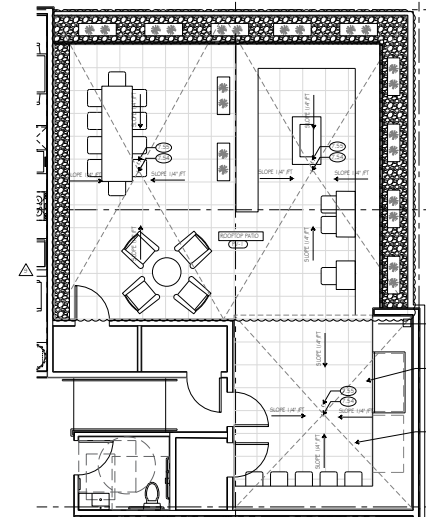

EXAMPLE 3

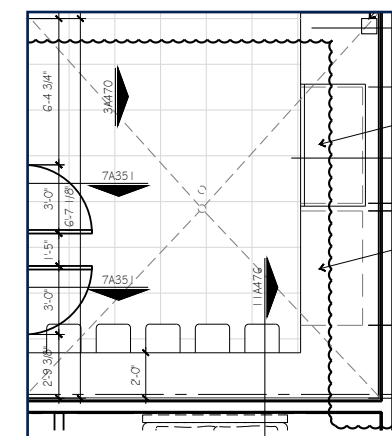

EXAMPLE 4

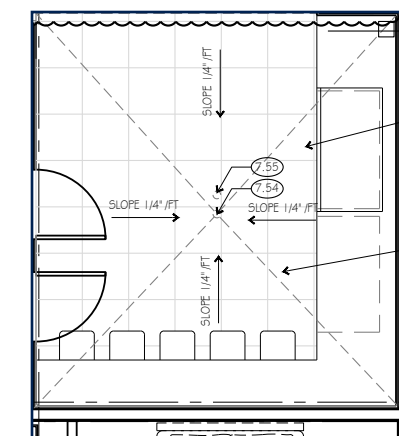

EXAMPLE 5

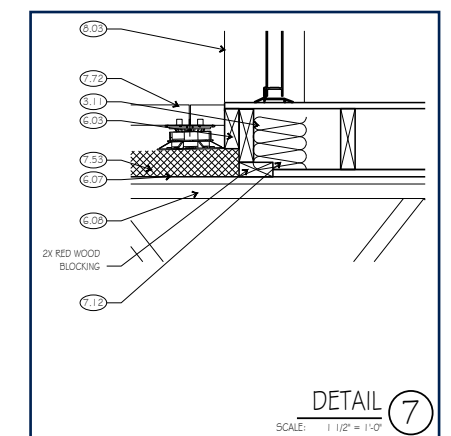



**REFERENCE
INFORMATION**

EVERY OUTDOOR POSSIBILITY. ONE TRUSTED PARTNER.

Complete solutions to simplify how pros design and deliver outstanding spaces.

RDI®
Railing

AMERIMIX®
Pre-Blended Mortar

ECHELON® MASONRY
Veneers & Structural Masonry

ELEMENTS™
Outdoor Cooking

CATALYST
Fencing

FREESTYLE™
Shade & Privacy

PEBBLETEC®
Pool Finishes

BELGARD®
Hardscapes



Oldcastle® APG transforms how pros approach outdoor projects with integrated hardscape, decking, fencing and railing solutions backed by the expertise and resources of one powerful partner. The result is streamlined planning, smoother installs and elevated spaces that help more clients Live Well Outside.

OldcastleAPG.com

BELGARD RESOURCES

DESIGN FILES

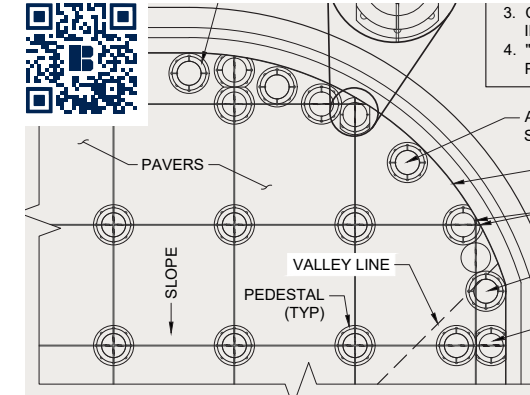

TECHNICAL RESOURCES



CONTINUING EDUCATION

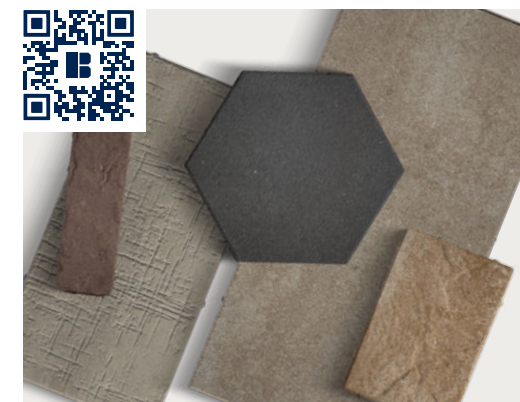
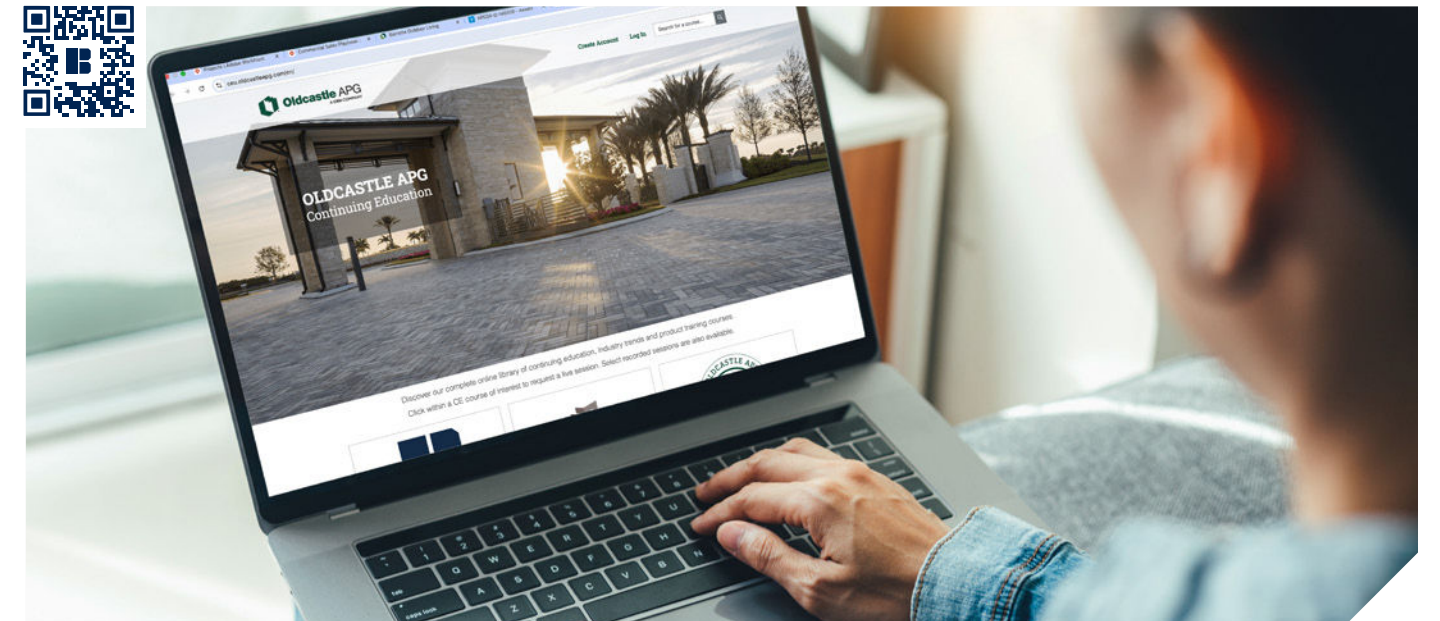

ORDER SAMPLES



FIND YOUR SALES REP

BELGARD®

AN OLDCASTLE® APG OUTDOOR BRAND

BELGARDCOMMERCIAL.COM

© 2026 Oldcastle® APG, Inc. All Rights Reserved. BELCOMM26-D-711050 | Revised 6/2026

