



BELGARD®
PAVES THE WAY™

T-BLOCK



**52" x 36" WOOD CAP
RECTANGULAR PLANTER**

T-BLOCK

COMPLETE THIS STEP
FIRST FOR ALL PROJECTS

BASE PREPARATION

Always level ground before installation

ON NEW OR EXISTING PATIO

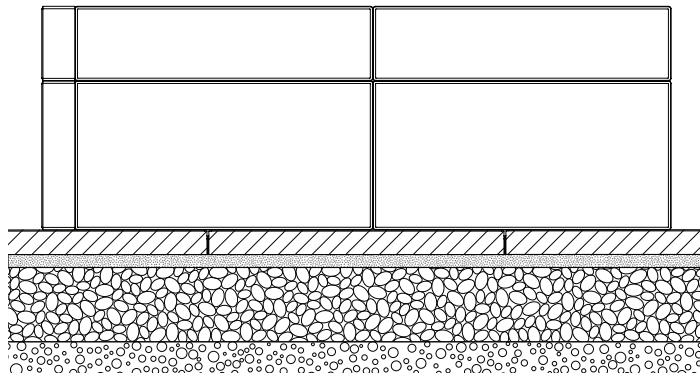

SLAB OR PAVER

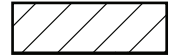

BEDDING SAND 1"

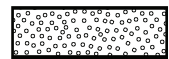

COMPACTED AGGREGATES 6"-8"



SOIL

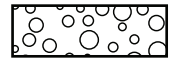

ON POURED CONCRETE

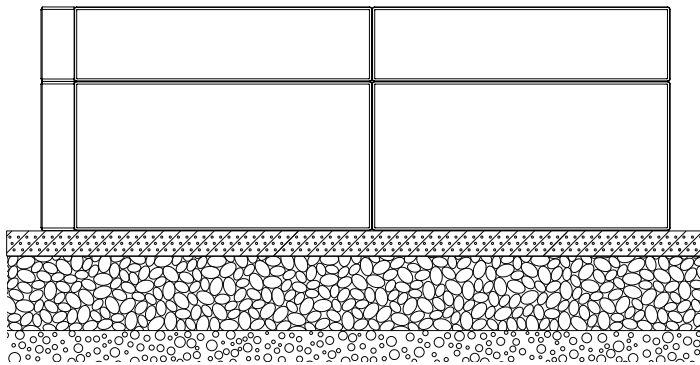

REINFORCED POURED CONCRETE FOUNDATION 2"

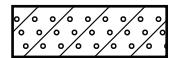

COMPACTED AGGREGATES 6"-8"



SOIL



ON COMPACTED FOUNDATION

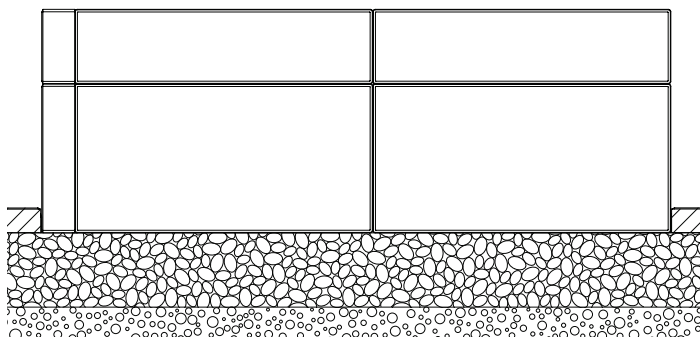

SLAB OR PAVER

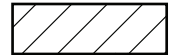

COMPACTED AGGREGATES 6"-8"



SOIL





T-BLOCK

52" x 36" WOOD CAP
RECTANGULAR PLANTER

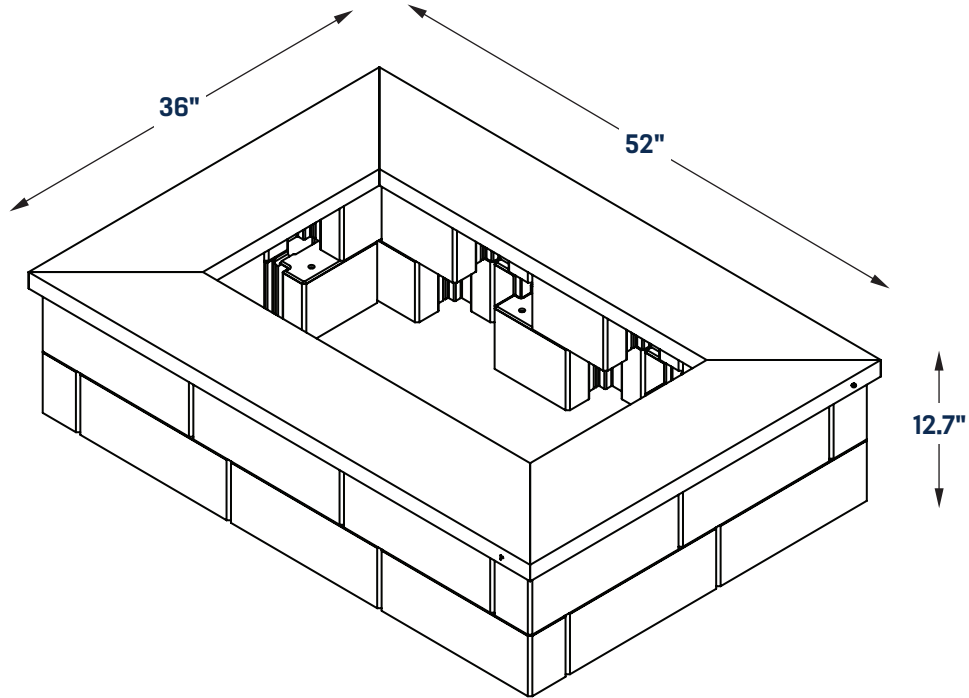

COMPONENTS

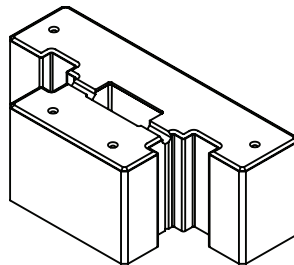
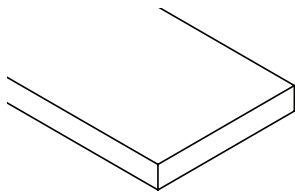

T-BLOCK

52" x 36" WOOD CAP
RECTANGULAR PLANTER

REQUIRED TOOLS

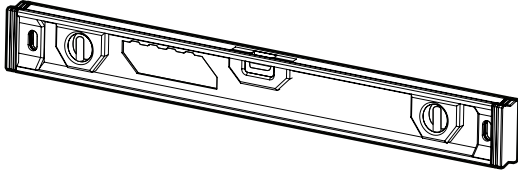

LEVEL

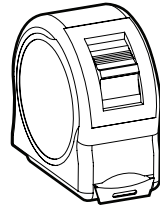

MEASURING
TAPE

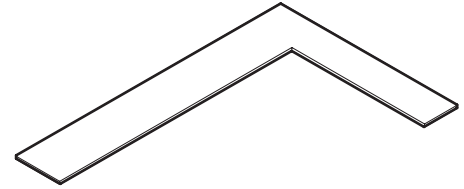

CARPENTER
SQUARE

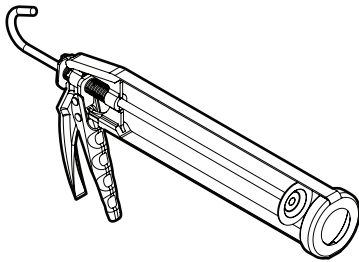

SILICONE
GUN

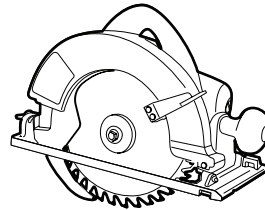

SKILSAW

SAFETY EQUIPMENT



SAFETY BOOTS

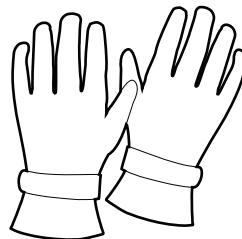

GLOVES

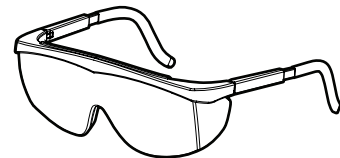

SAFETY GLASSES

T-BLOCK

52" x 36" WOOD CAP RECTANGULAR PLANTER

1

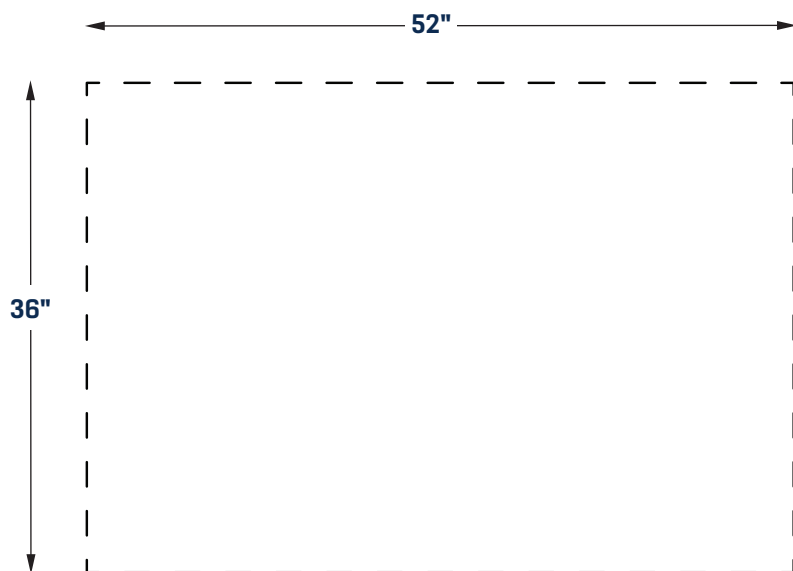

2

Do not forget to add glue in the cavities before laying down your next level.

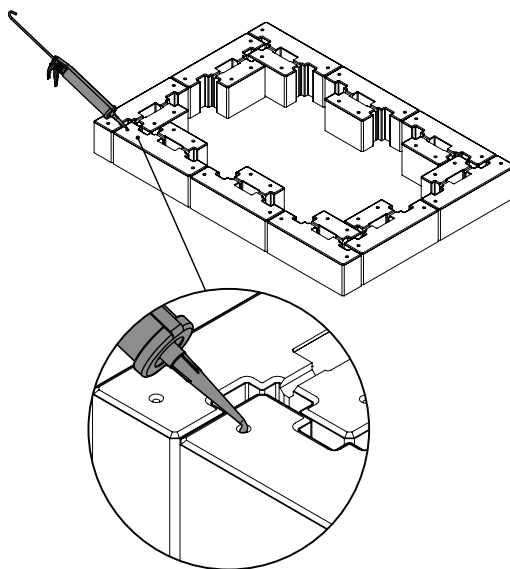
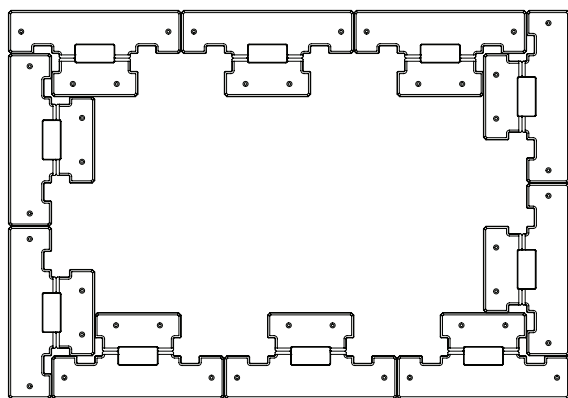

T-BLOCK

52" x 36" WOOD CAP RECTANGULAR PLANTER

- 3 Do not forget to add glue in the cavities before laying down your next level.

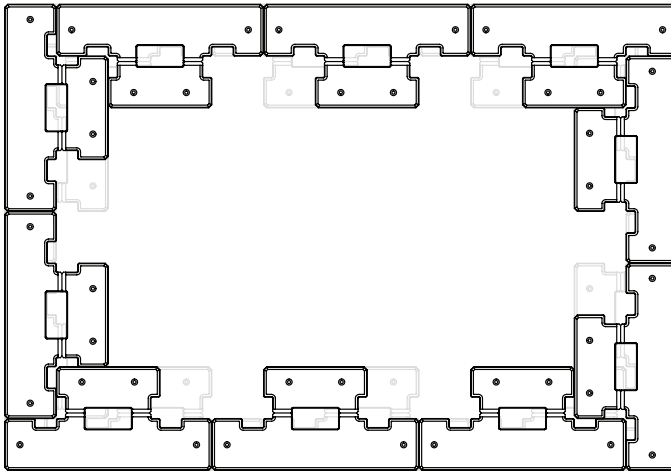
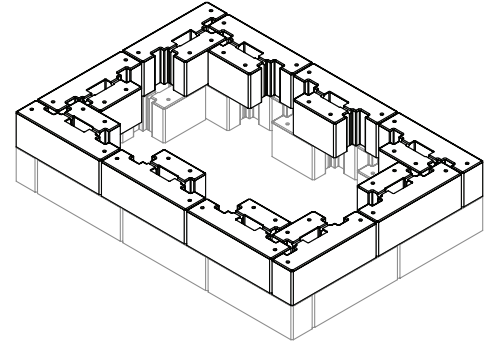

WOOD CUTS

□ 2" x 10" x 8'

A = 53 $\frac{1}{4}$ "

B = 37 $\frac{1}{4}$ "

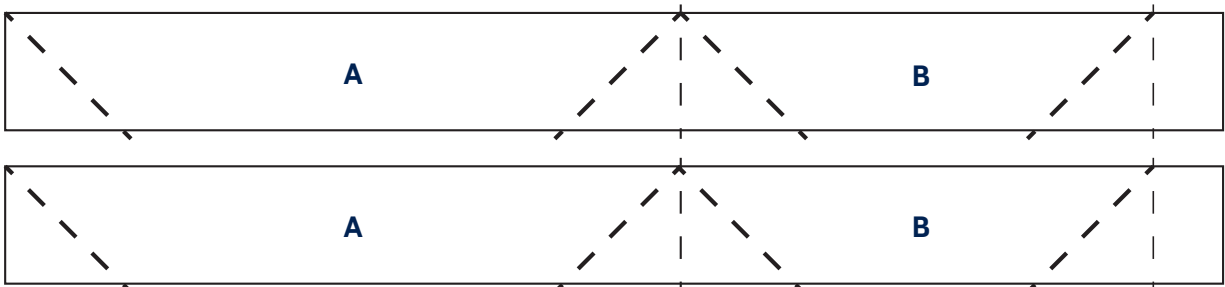
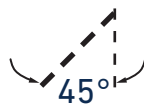

T-BLOCK

52" x 36" WOOD CAP RECTANGULAR PLANTER

- 4 Put the angle pieces together to create the frame shape, keeping all edges aligned while the glue sets.

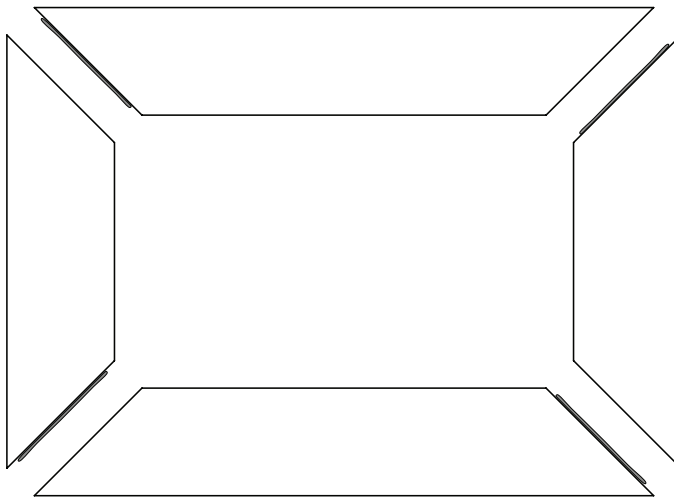
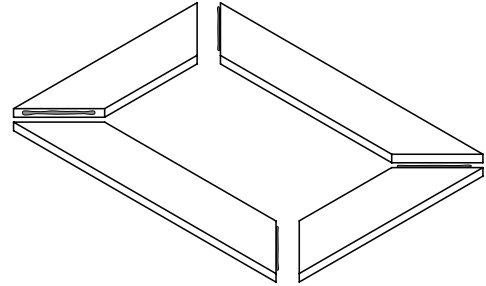

- 5 Add the screws in each corner, making sure they go through the middle of the boards for a solid connection.

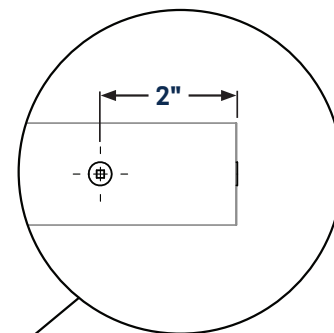
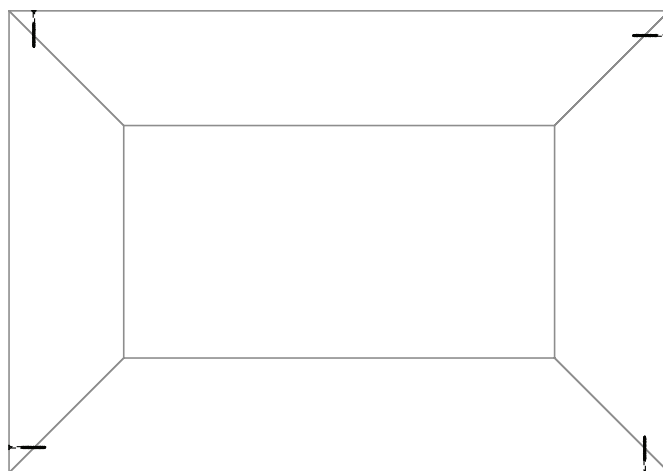

T-BLOCK

52" x 36" WOOD CAP RECTANGULAR PLANTER

- 6 Do not forget to add glue in the cavities before laying down the frame.

