



BELGARD®
PAVES THE WAY™

T-BLOCK



52" x 36"
RECTANGULAR PLANTER

T-BLOCK

COMPLETE THIS STEP
FIRST FOR ALL PROJECTS

BASE PREPARATION

Always level ground before installation

ON NEW OR EXISTING PATIO

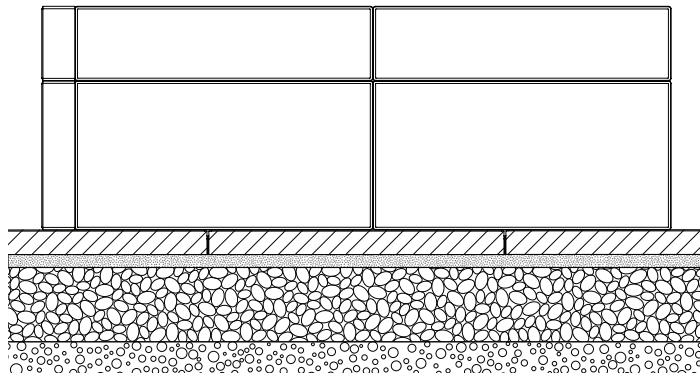

SLAB OR PAVER

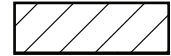

BEDDING SAND 1"



COMPACTED AGGREGATES 6"-8"



SOIL

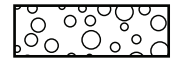

ON POURED CONCRETE

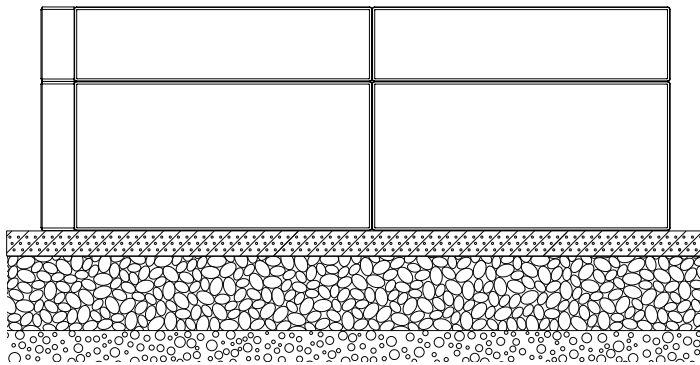

REINFORCED POURED CONCRETE FOUNDATION 2"

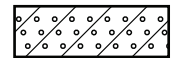

COMPACTED AGGREGATES 6"-8"



SOIL



ON COMPACTED FOUNDATION

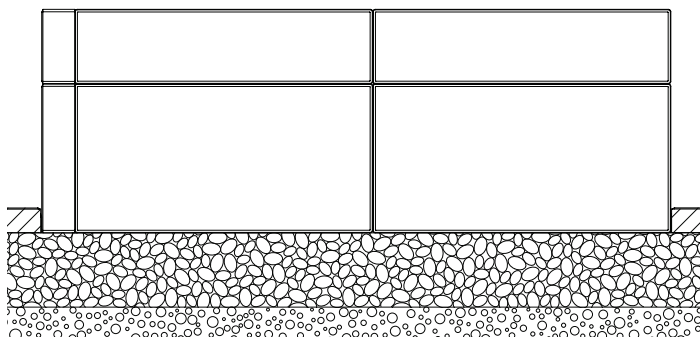

SLAB OR PAVER



COMPACTED AGGREGATES 6"-8"



SOIL





T-BLOCK

52" x 36"
RECTANGULAR PLANTER

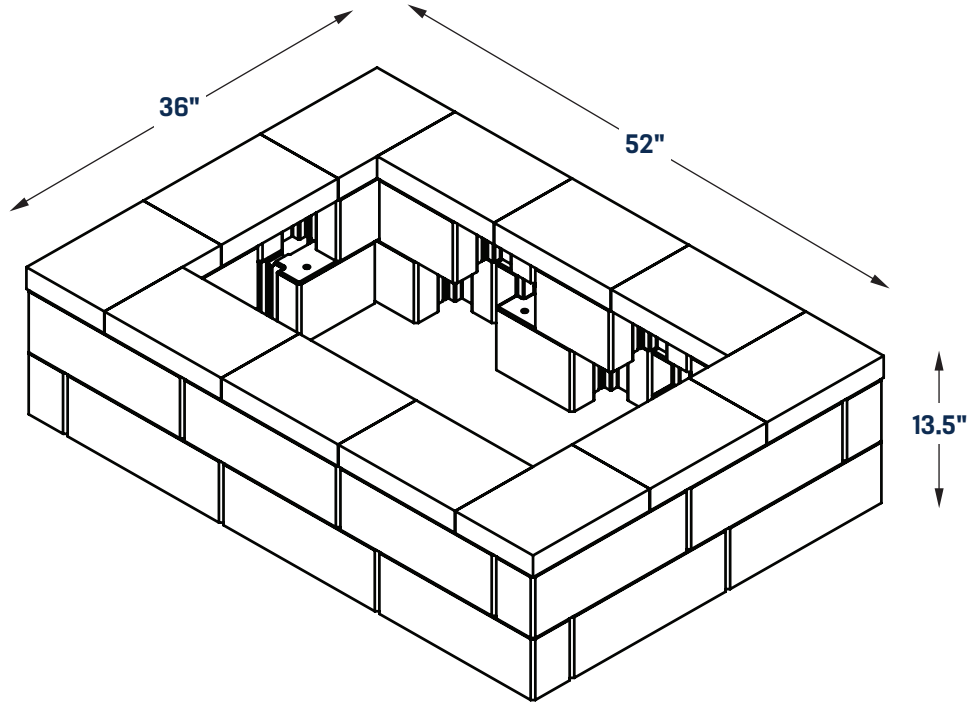

COMPONENTS

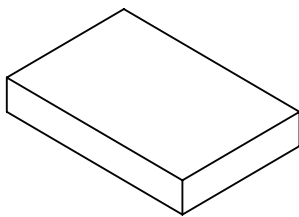

Cap (x12)

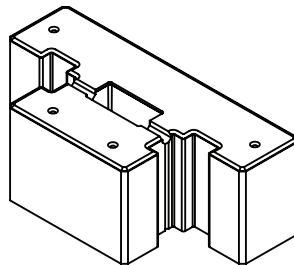

T-Block (x20)



Glue Tube

T-BLOCK

52" x 36"
RECTANGULAR PLANTER

REQUIRED TOOLS

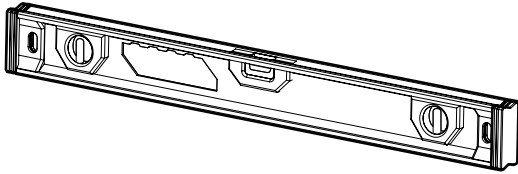

LEVEL

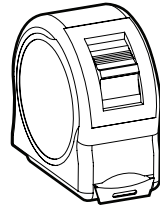

MEASURING
TAPE

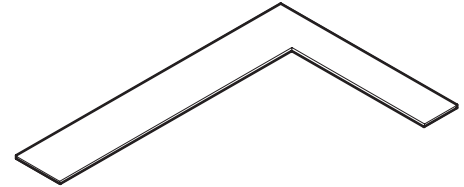

CARPENTER
SQUARE

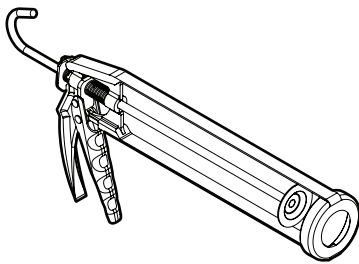

SILICONE
GUN

SAFETY EQUIPMENT



SAFETY BOOTS

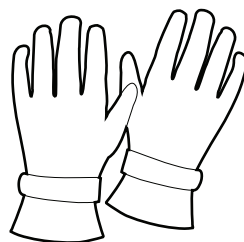

GLOVES

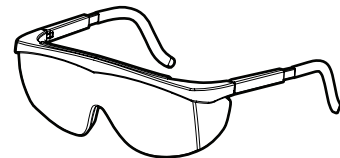

SAFETY GLASSES



T-BLOCK

52" x 36"
RECTANGULAR PLANTER

1

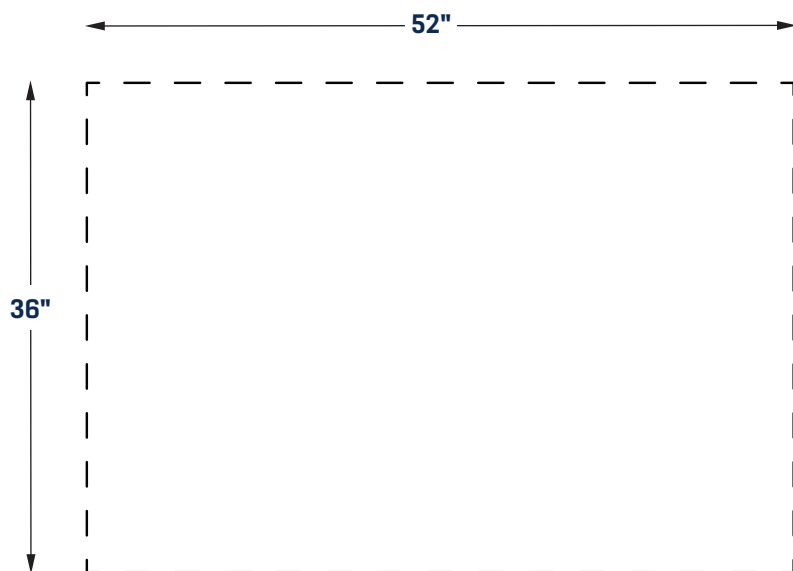

2

Do not forget to add glue in the cavities before laying down your next level.

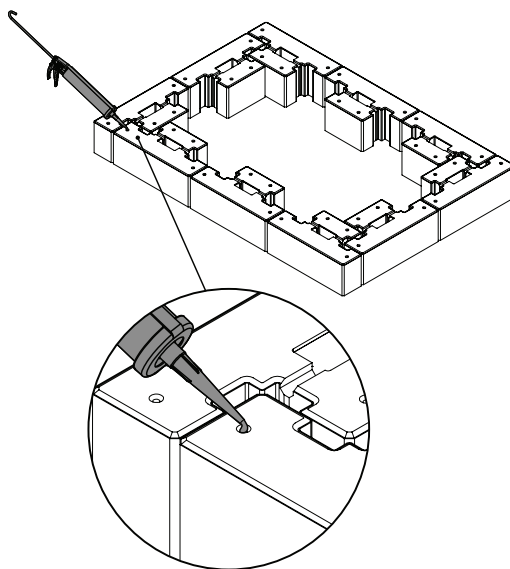
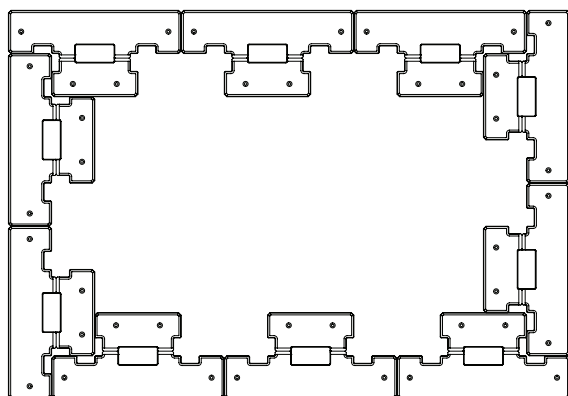

T-BLOCK

52" x 36"
RECTANGULAR PLANTER

- 3 Do not forget to add glue in the cavities before laying down your next level.

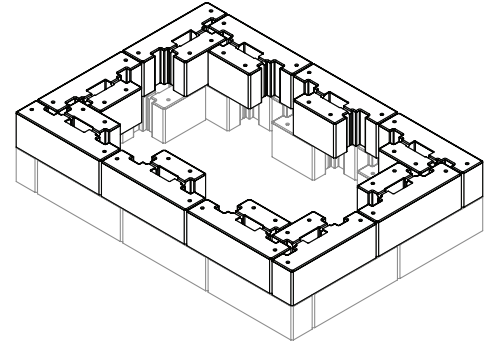
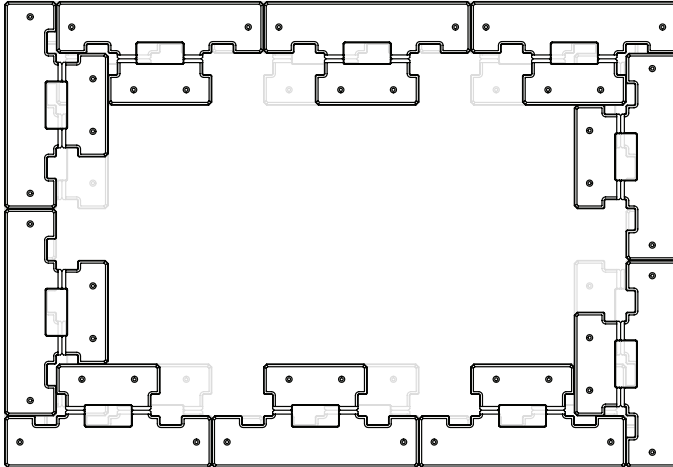

- 4 Do not forget to add glue in the cavities before laying down your next level.

