



BELGARD®  
PAVES THE WAY™

# T-BLOCK



**COLUMN  
AND PLANTER**

# T-BLOCK

COMPLETE THIS STEP  
FIRST FOR ALL PROJECTS

## BASE PREPARATION

Always level ground before installation

### ON NEW OR EXISTING PATIO

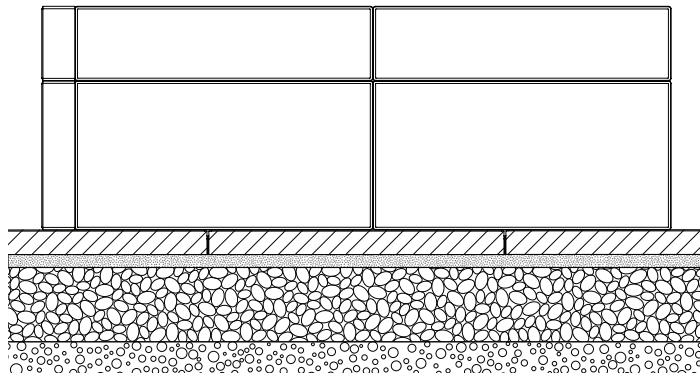

### SLAB OR PAVER

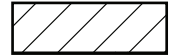

### BEDDING SAND 1"

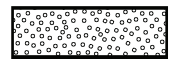

### COMPACTED AGGREGATES 6"-8"



### SOIL

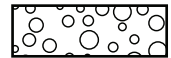

### ON POURED CONCRETE

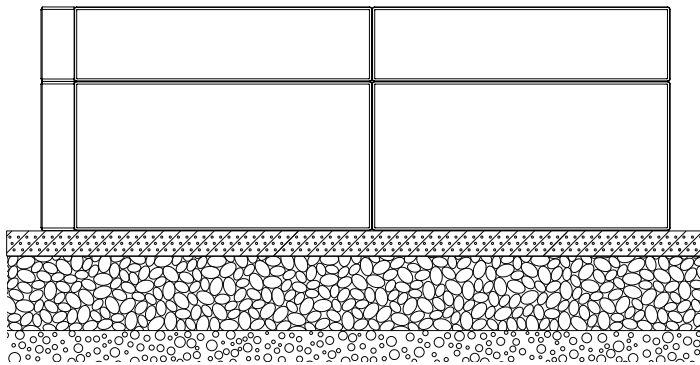

### REINFORCED POURED CONCRETE FOUNDATION 2"

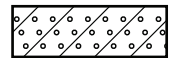

### COMPACTED AGGREGATES 6"-8"



### SOIL

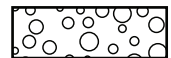

### ON COMPACTED FOUNDATION

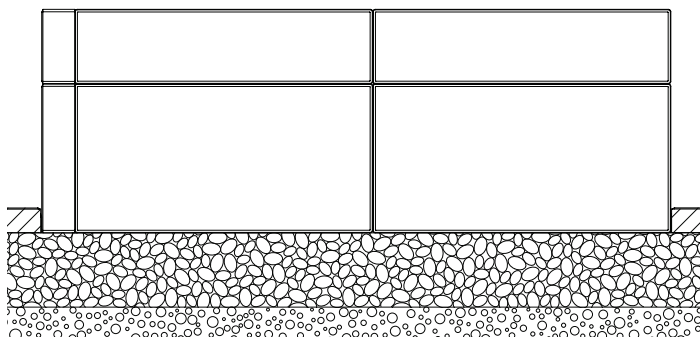

### SLAB OR PAVER



### COMPACTED AGGREGATES 6"-8"



### SOIL



# T-BLOCK

## COLUMN AND PLANTER

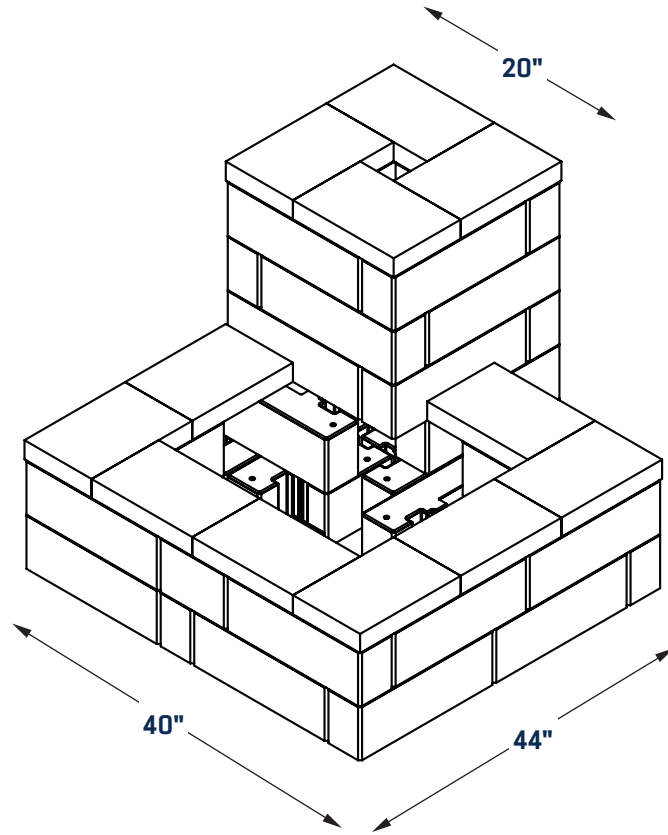

### COMPONENTS

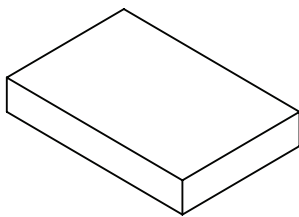

**Cap (x12)**

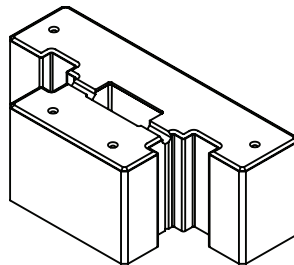

**T-Block (x36)**



**Glue Tube**

# T-BLOCK

## COLUMN AND PLANTER

### REQUIRED TOOLS

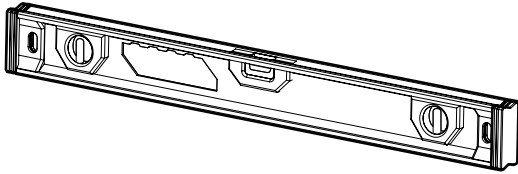

**LEVEL**

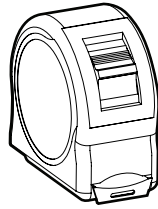

**MEASURING  
TAPE**

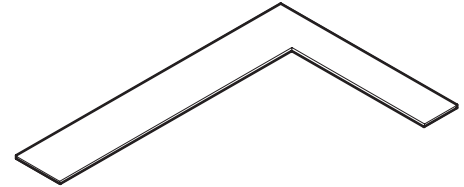

**CARPENTER  
SQUARE**

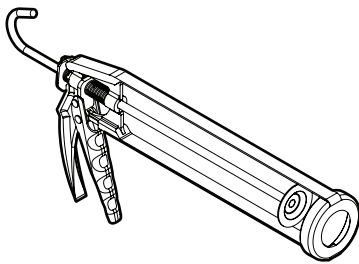

**SILICONE  
GUN**

### SAFETY EQUIPMENT



**SAFETY BOOTS**

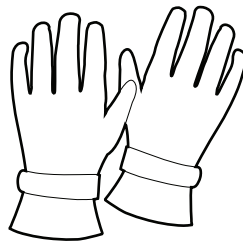

**GLOVES**

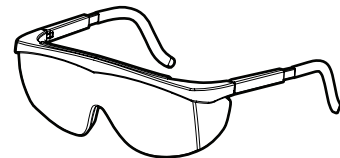

**SAFETY GLASSES**

# T-BLOCK

## COLUMN AND PLANTER

1

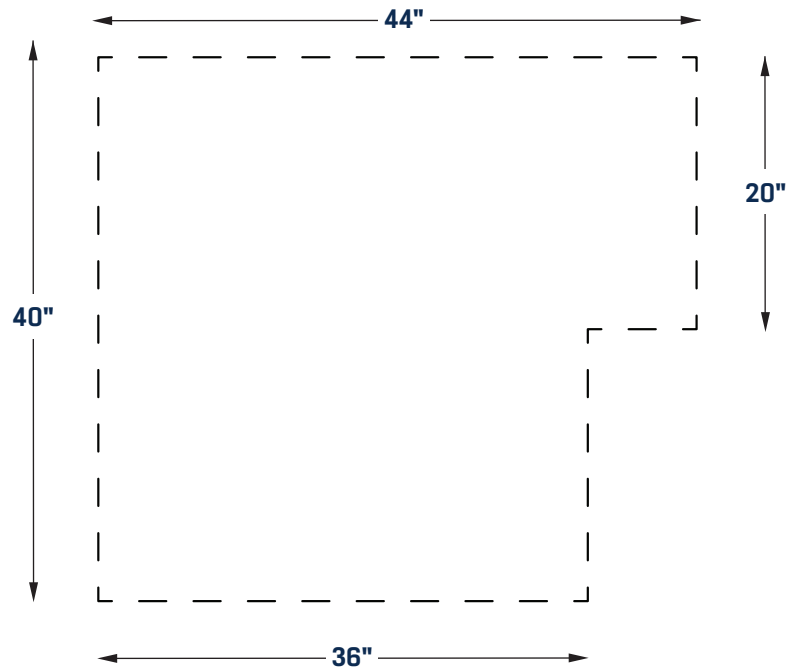

2

Do not forget to add glue in the cavities before laying down your next level.

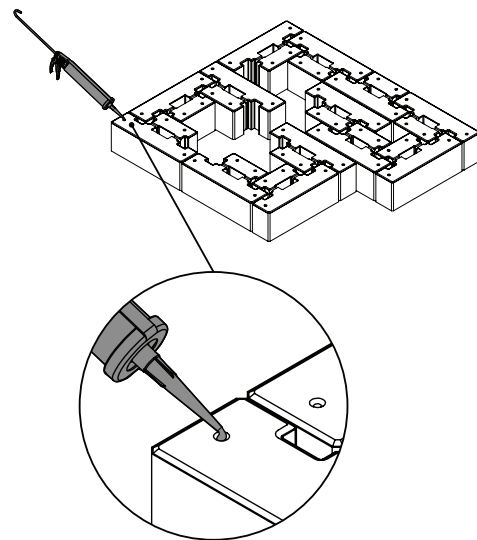
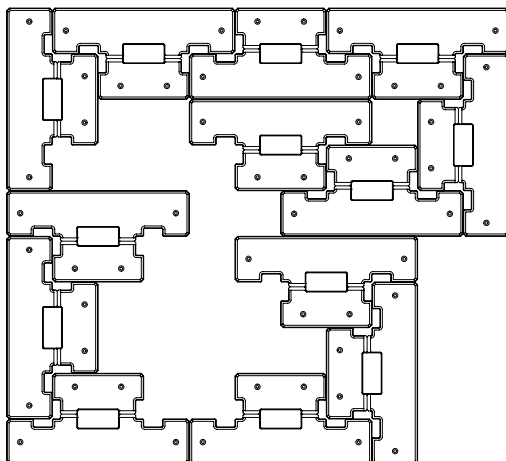

# T-BLOCK

## COLUMN AND PLANTER

- 3 Do not forget to add glue in the cavities before laying down your next level.

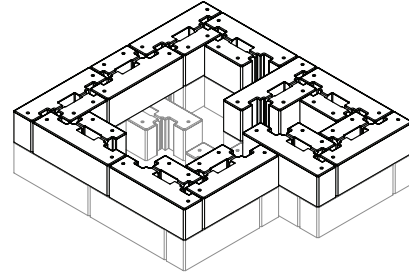
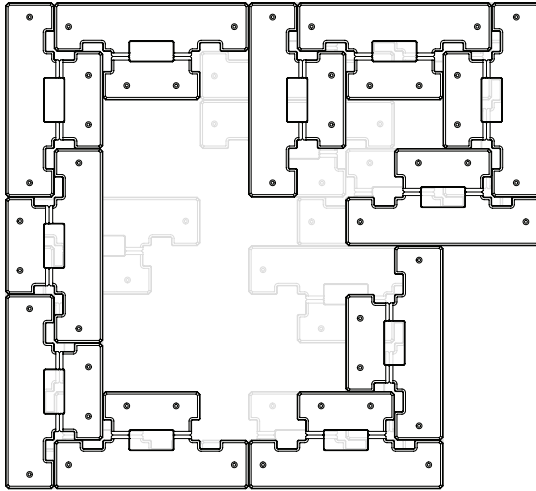

- 4 Do not forget to add glue in the cavities before laying down your next level.

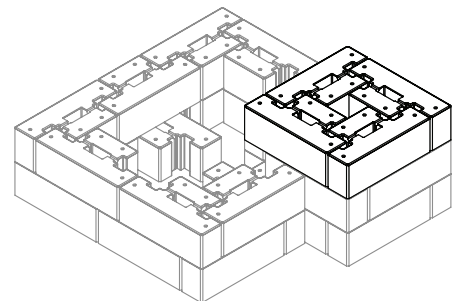
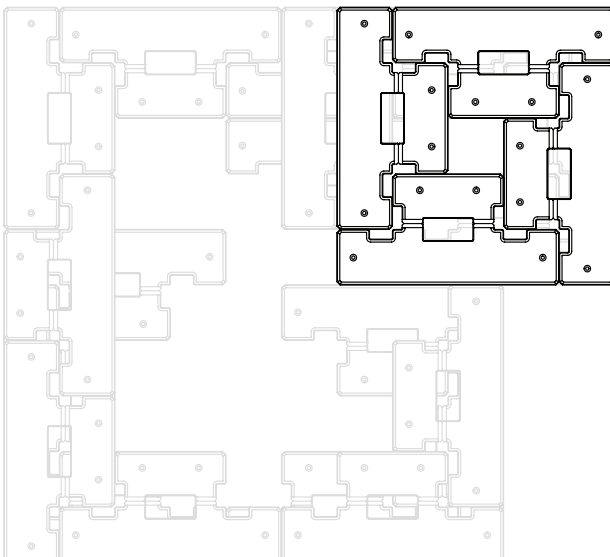

# T-BLOCK

## COLUMN AND PLANTER

- 5 Do not forget to add glue in the cavities before laying down your next level.

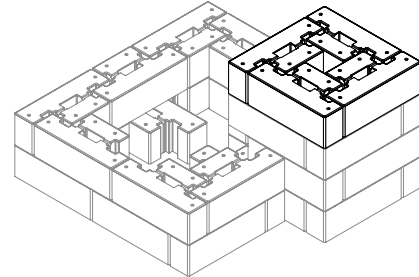
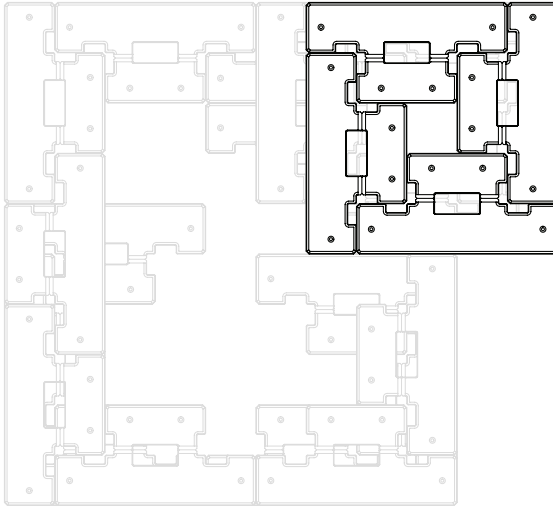

- 6 Do not forget to add glue in the cavities before laying down your next level.

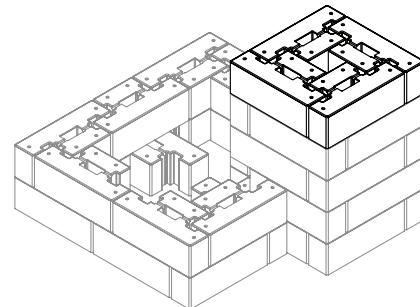
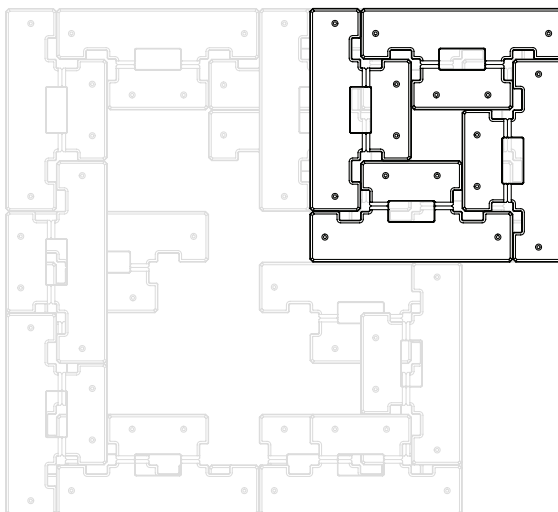

# T-BLOCK

## COLUMN AND PLANTER

- ⑦ Do not forget to add glue in the cavities before laying down your next level.

