



BELGARD®
PAVES THE WAY™

T-BLOCK



**COFFEE TABLE
- WOOD TOP**

T-BLOCK

COMPLETE THIS STEP
FIRST FOR ALL PROJECTS

BASE PREPARATION

Always level ground before installation

ON NEW OR EXISTING PATIO

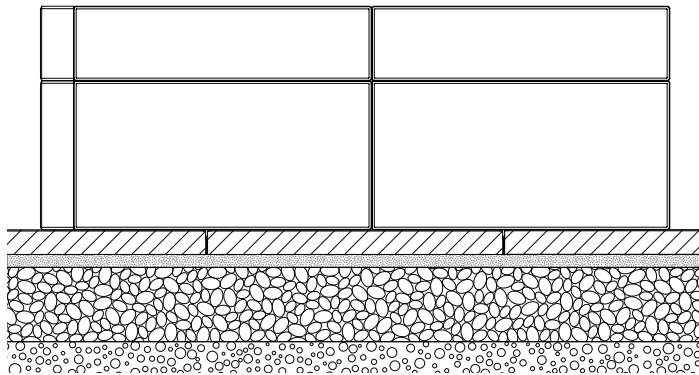

SLAB OR PAVER

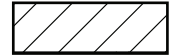

BEDDING SAND 1"

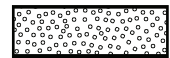

COMPACTED AGGREGATES 6"-8"



SOIL

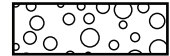

ON POURED CONCRETE

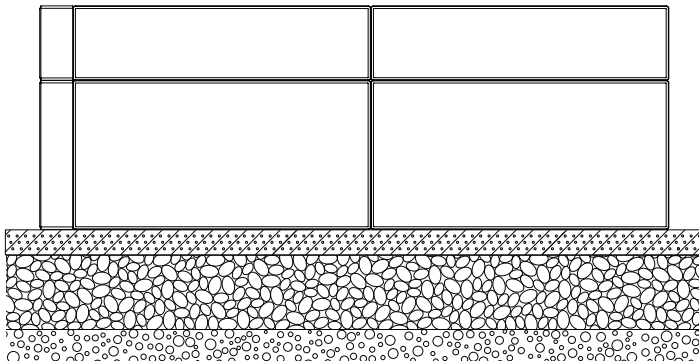

REINFORCED POURED CONCRETE
FOUNDATION 2"

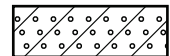

COMPACTED AGGREGATES 6"-8"



SOIL



ON COMPACTED FOUNDATION

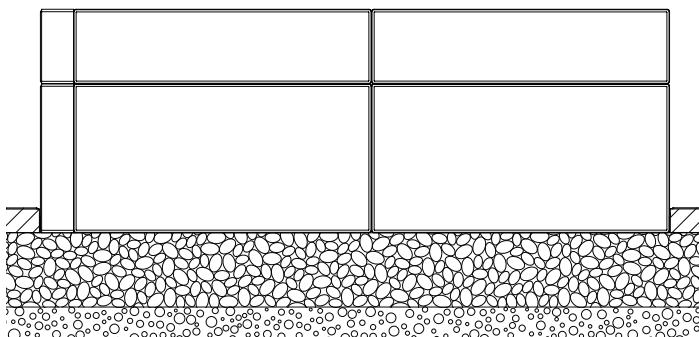

SLAB OR PAVER



COMPACTED AGGREGATES 6"-8"



SOIL

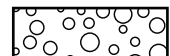

T-BLOCK

COFFEE TABLE
- WOOD TOP

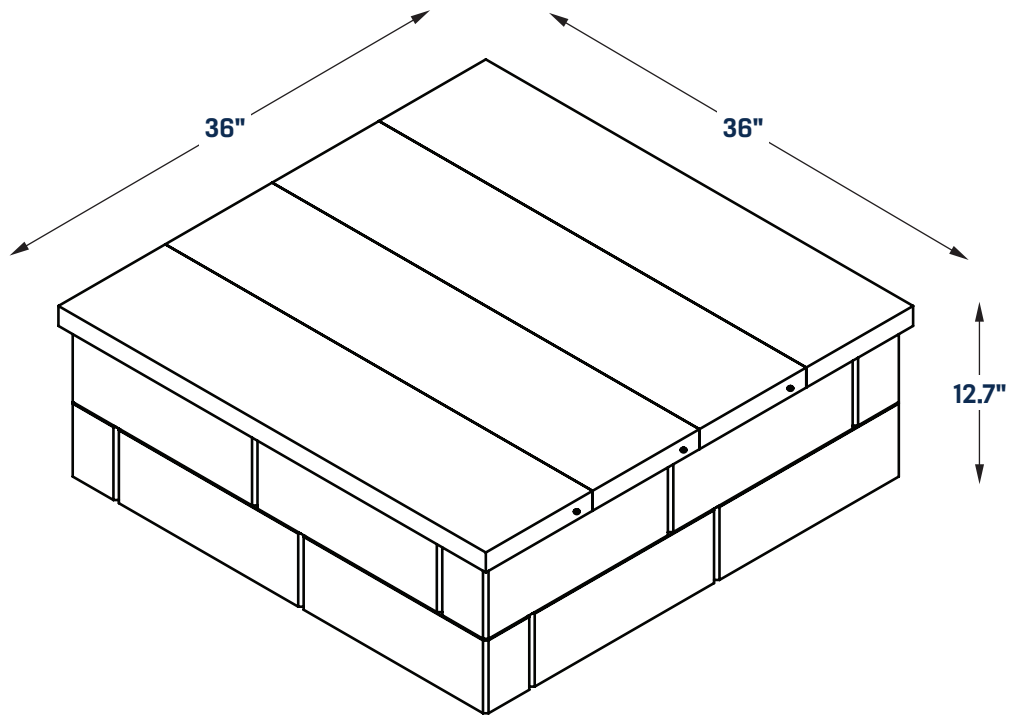

COMPONENTS

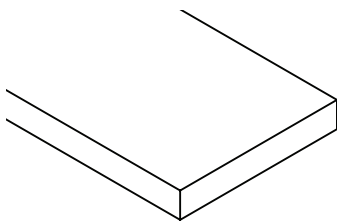

2" x 10" x 8' (x3)

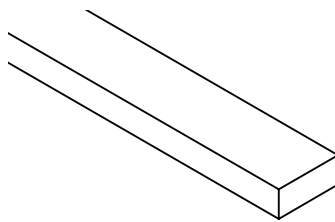

2" x 4" x 8' (x1)

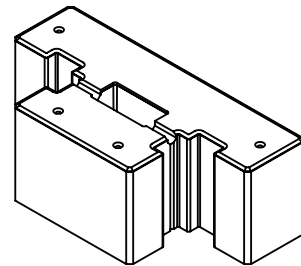

T-Block (x16)



Glue Tube



No.8 x 3" (x6)



No.8 x 2 1/2" (x18)

T-BLOCK

**COFFEE TABLE
- WOOD TOP**

REQUIRED TOOLS

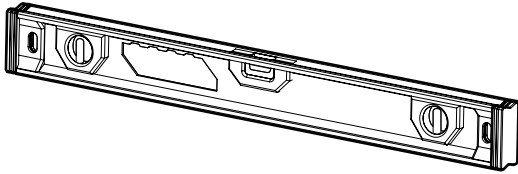

LEVEL

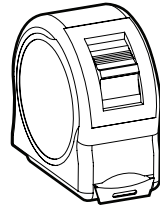

**MEASURING
TAPE**

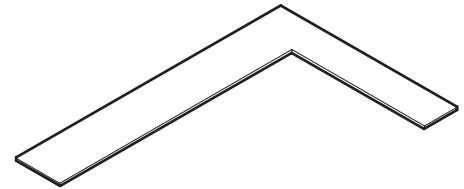

**CARPENTER
SQUARE**

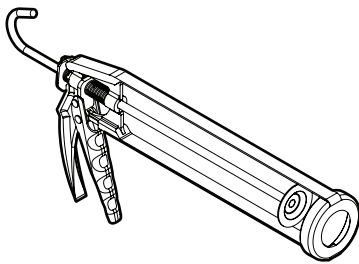

**SILICONE
GUN**

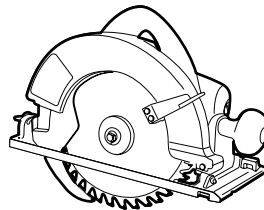

SKILSAW

SAFETY EQUIPMENT



SAFETY BOOTS

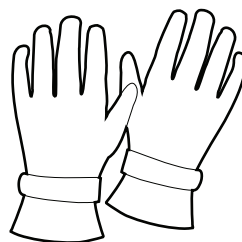

GLOVES

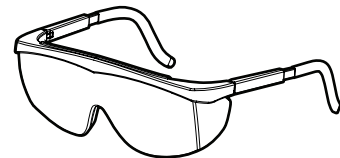

SAFETY GLASSES

T-BLOCK

COFFEE TABLE - WOOD TOP

1

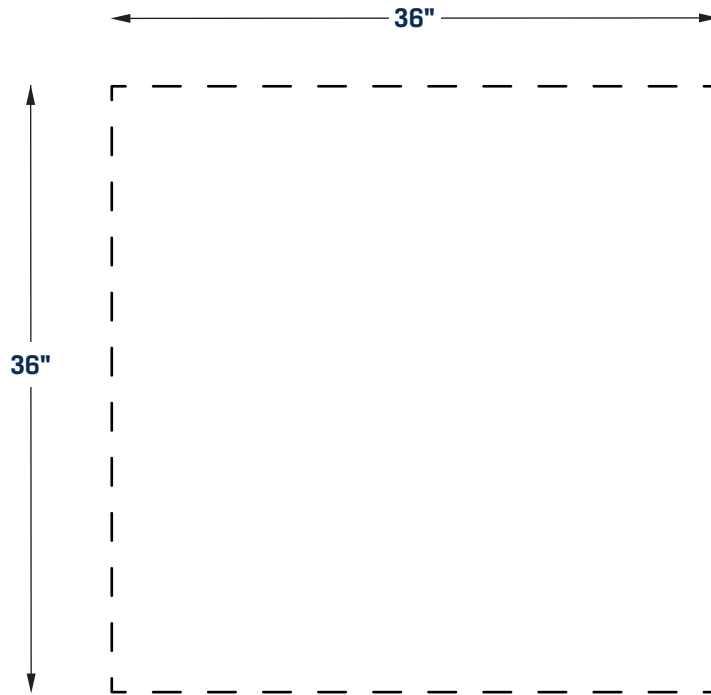

2

Do not forget to add glue in the cavities before laying down your next level.

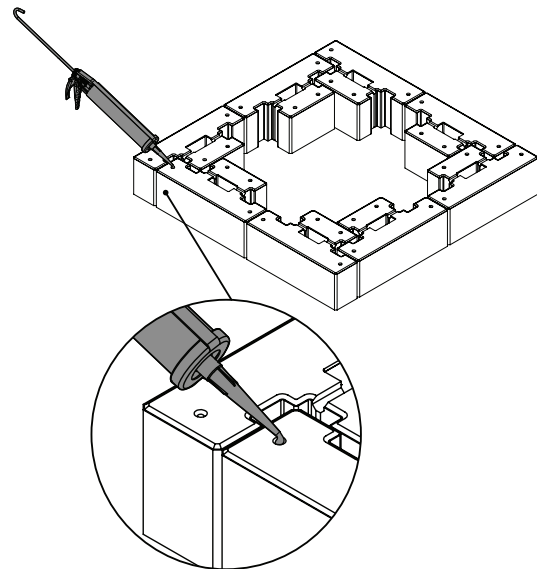
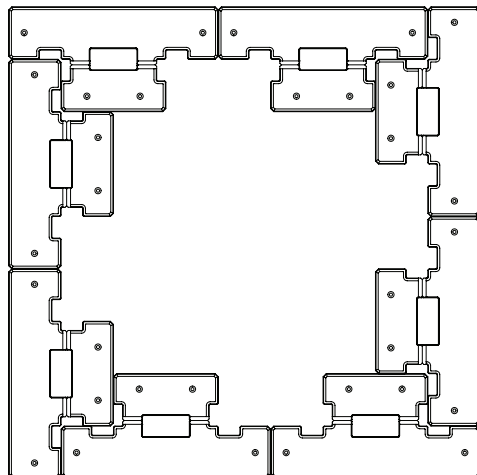

T-BLOCK

COFFEE TABLE - WOOD TOP

- 3 Do not forget to add glue in the cavities before laying down your next level.

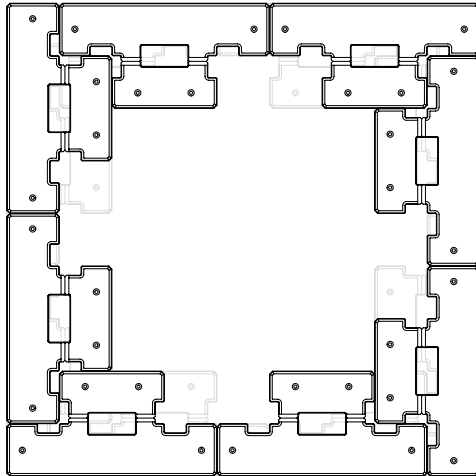
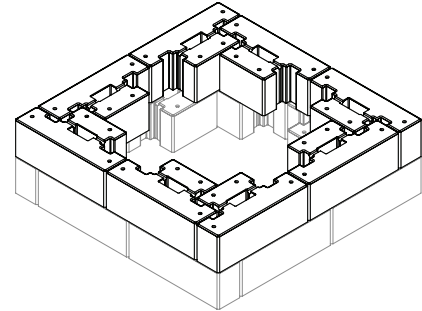

WOOD CUTS

- 2" x 6" x 8' A = 27³/₄"
■ 2" x 10" x 8' B = 37"

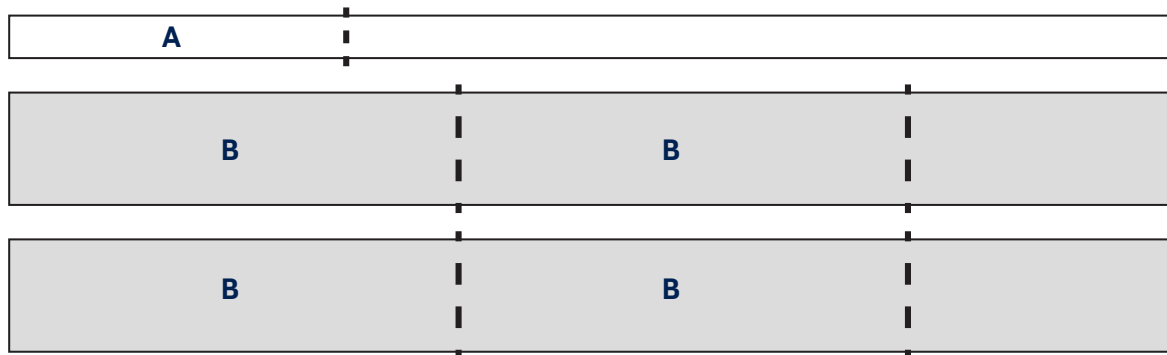

T-BLOCK

COFFEE TABLE - WOOD TOP

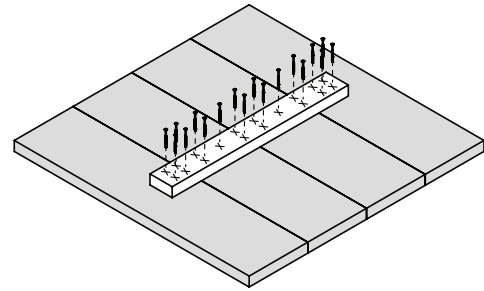
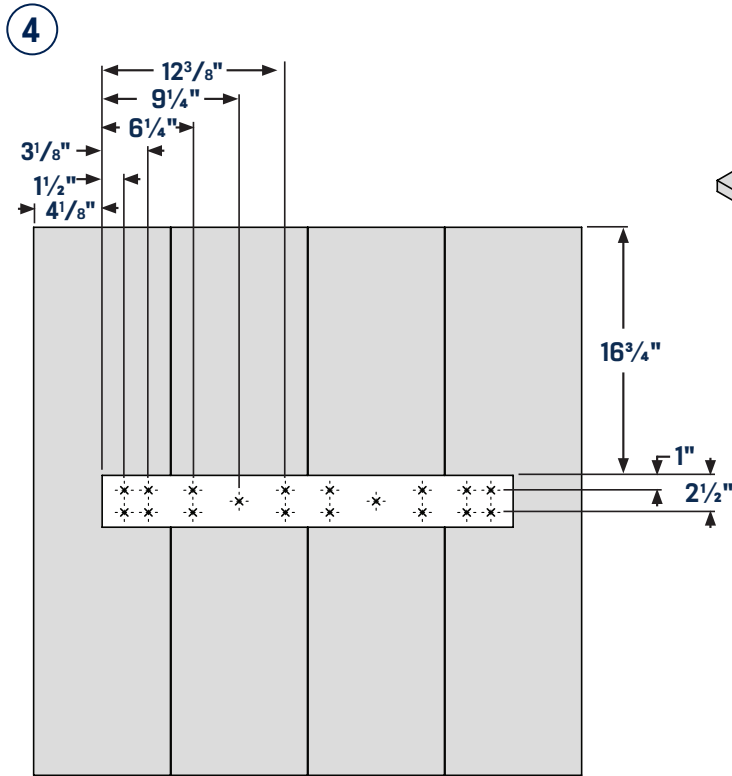

- 5 Attach the planks using screws (3") at a 45° angle. Make sure each screw is placed in the middle of the lumber so it connects both boards securely.

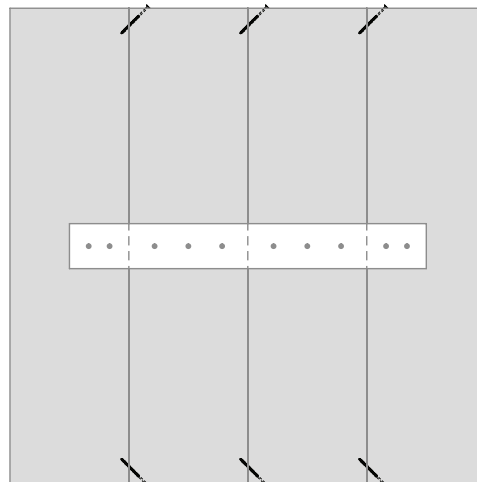

T-BLOCK

COFFEE TABLE - WOOD TOP

- 6 Do not forget to add glue in the cavities before laying down the top.

