



BELGARD®
PAVES THE WAY™

T-BLOCK



**BENCH AND
PLANTER**

T-BLOCK

COMPLETE THIS STEP
FIRST FOR ALL PROJECTS

BASE PREPARATION

Always level ground before installation

ON NEW OR EXISTING PATIO

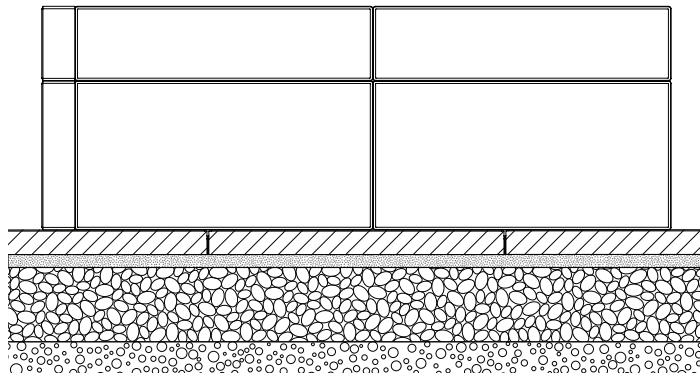

SLAB OR PAVER

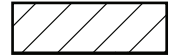

BEDDING SAND 1"

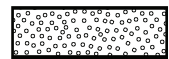

COMPACTED AGGREGATES 6"-8"



SOIL

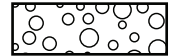

ON POURED CONCRETE

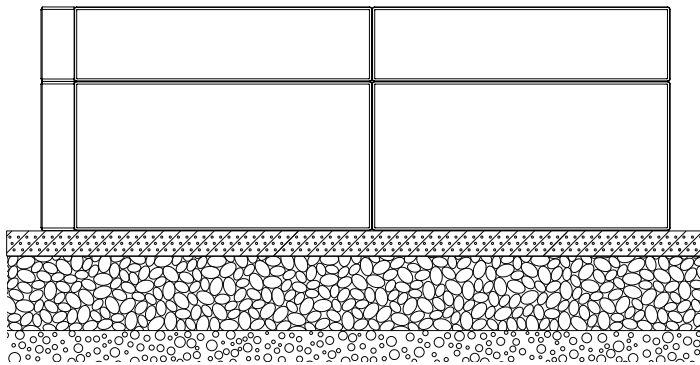

REINFORCED POURED CONCRETE FOUNDATION 2"

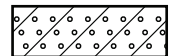

COMPACTED AGGREGATES 6"-8"



SOIL



ON COMPACTED FOUNDATION

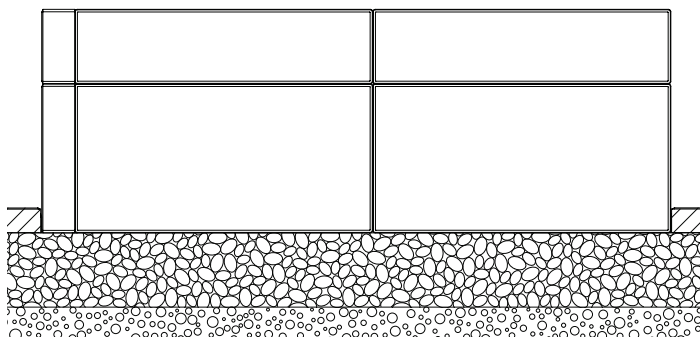

SLAB OR PAVER



COMPACTED AGGREGATES 6"-8"



SOIL

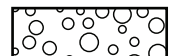

T-BLOCK

BENCH AND PLANTER

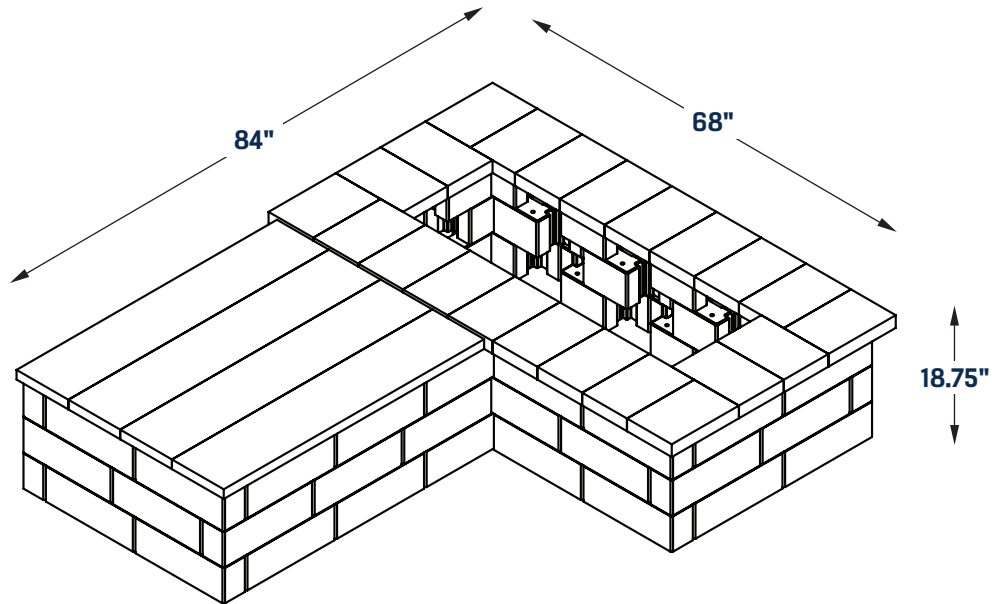

COMPONENTS

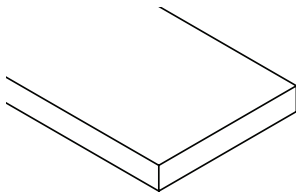

2" x 10" x 8' (x2)

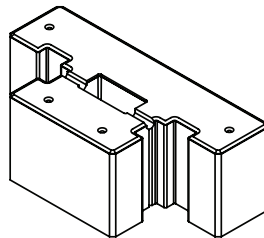

T-Block (x60)

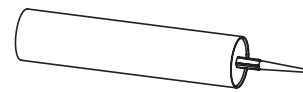

Glue Tube

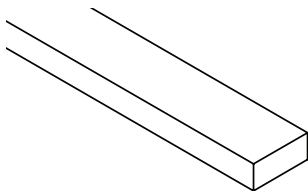

2" x 4" x 8' (x1)

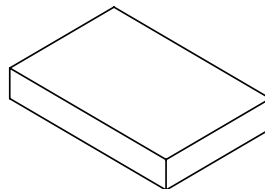

Cap (x22)



No.8 x 2 1/2" (x24)

T-BLOCK

BENCH AND PLANTER

REQUIRED TOOLS

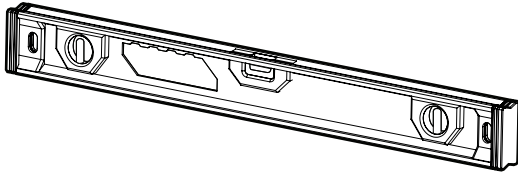

LEVEL

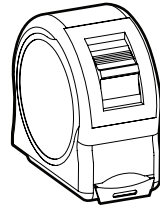

**MEASURING
TAPE**

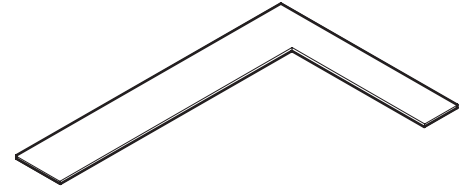

**CARPENTER
SQUARE**

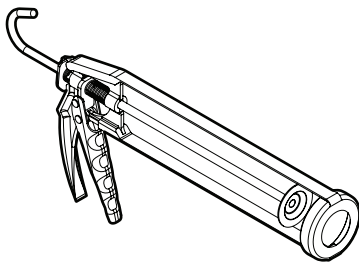

**SILICONE
GUN**

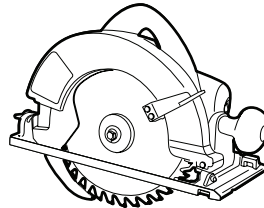

SKILSAW

SAFETY EQUIPMENT



SAFETY BOOTS

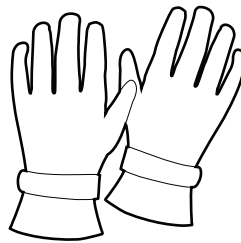

GLOVES

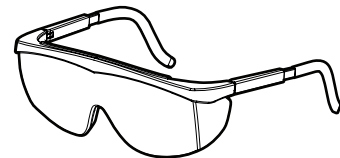

SAFETY GLASSES

T-BLOCK

BENCH AND PLANTER

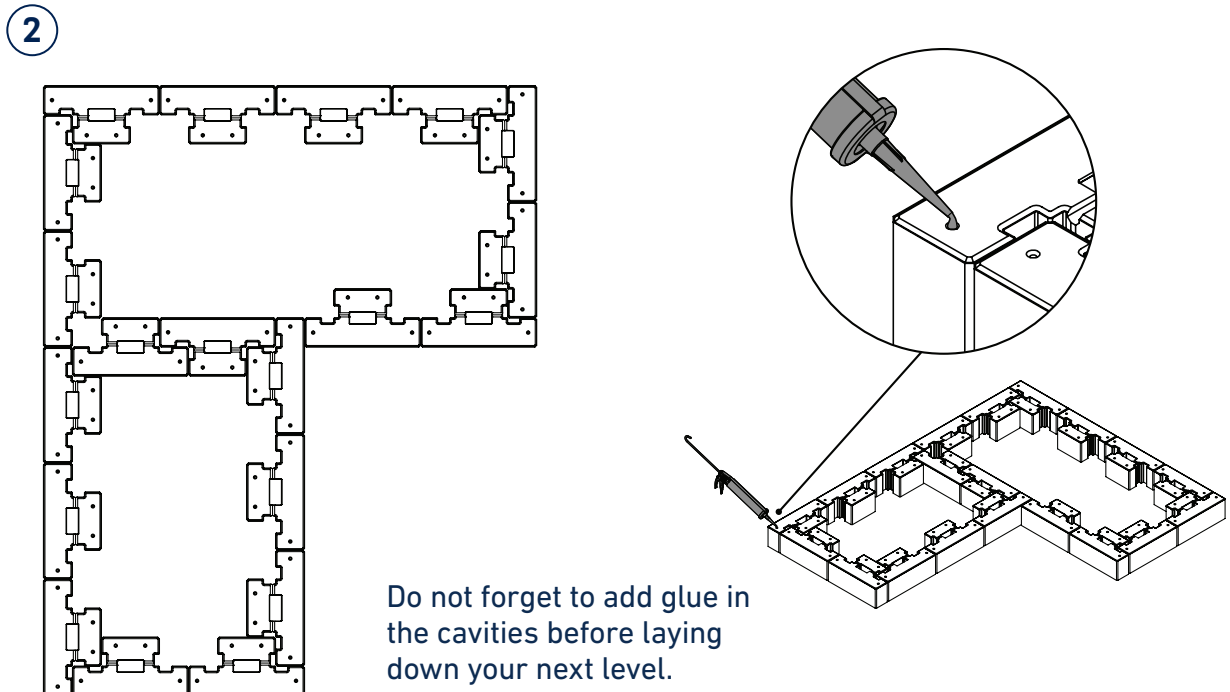
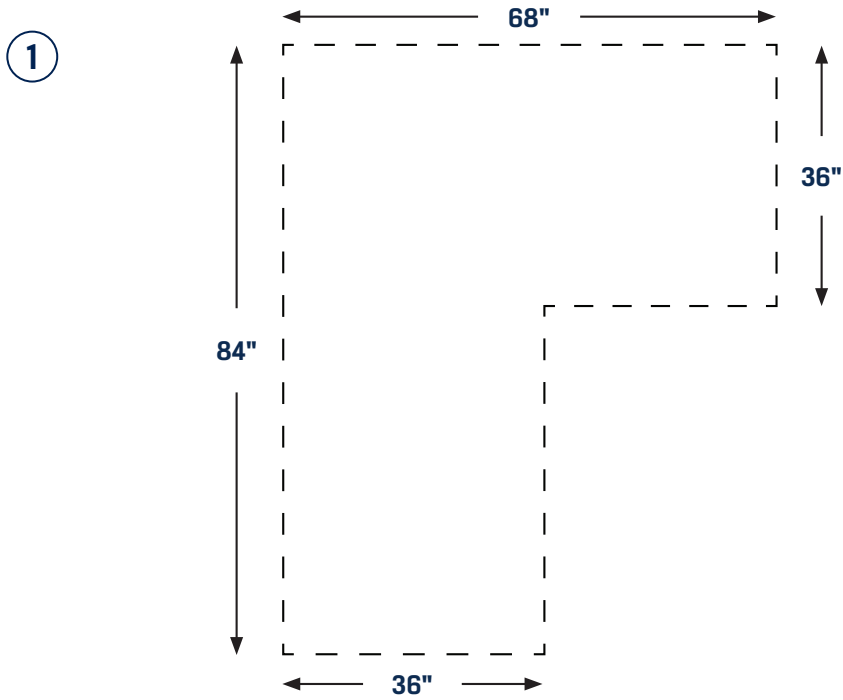

T-BLOCK

BENCH AND PLANTER

3

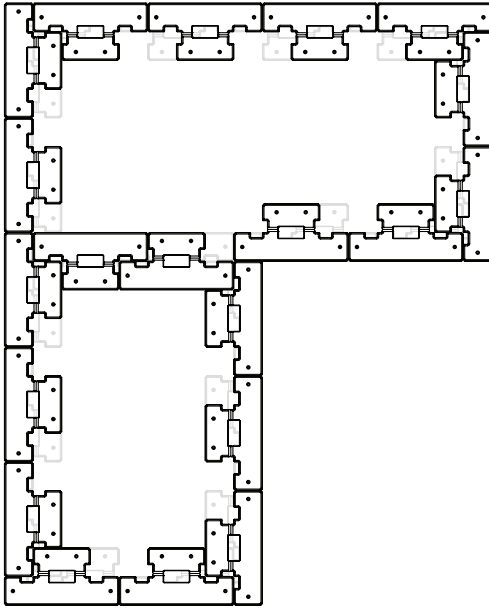

Do not forget to add glue in the cavities before laying down your next level.

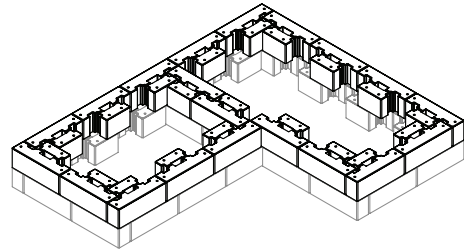

4

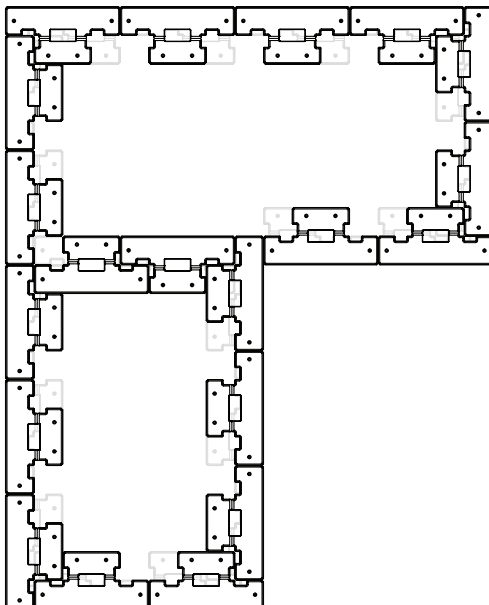

Do not forget to add glue in the cavities before laying down your next level.

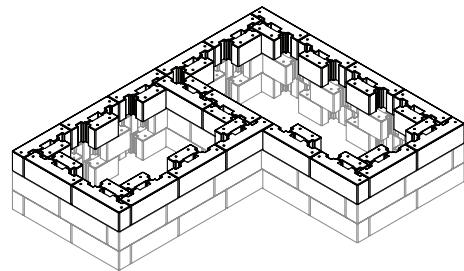

T-BLOCK

BENCH AND PLANTER

5

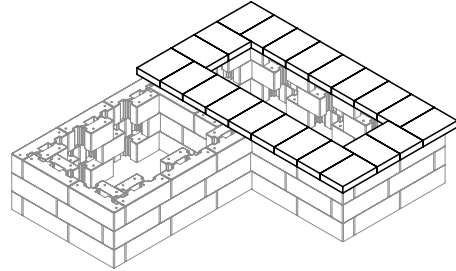
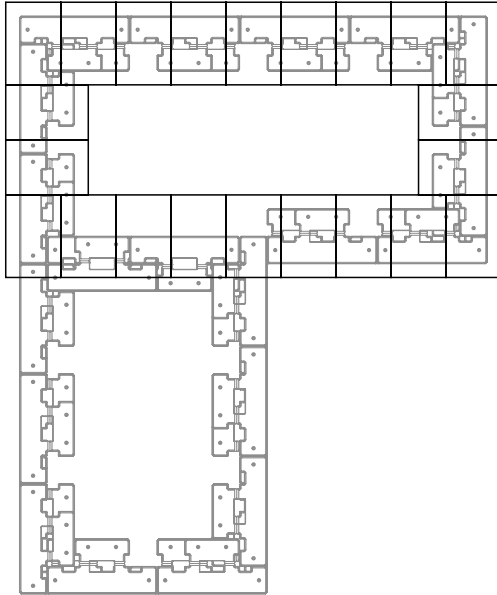

Do not forget to add glue in the cavities before laying down your next level.

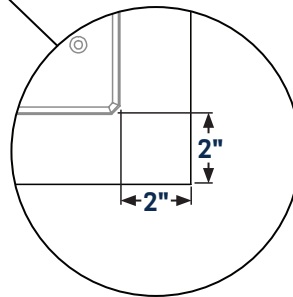

WOOD CUTS

- 2" x 4" x 8' A = 27³/₄"
- 2" x 10" x 8' B = 46¹/₂"

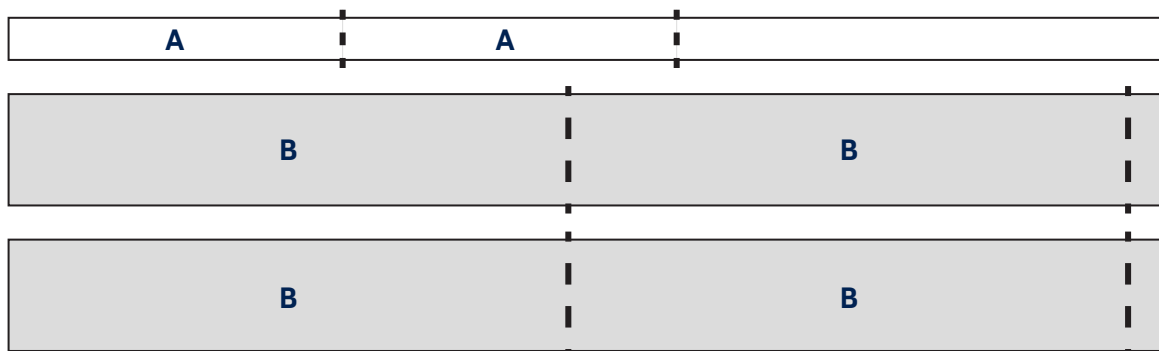

T-BLOCK

BENCH AND PLANTER

6

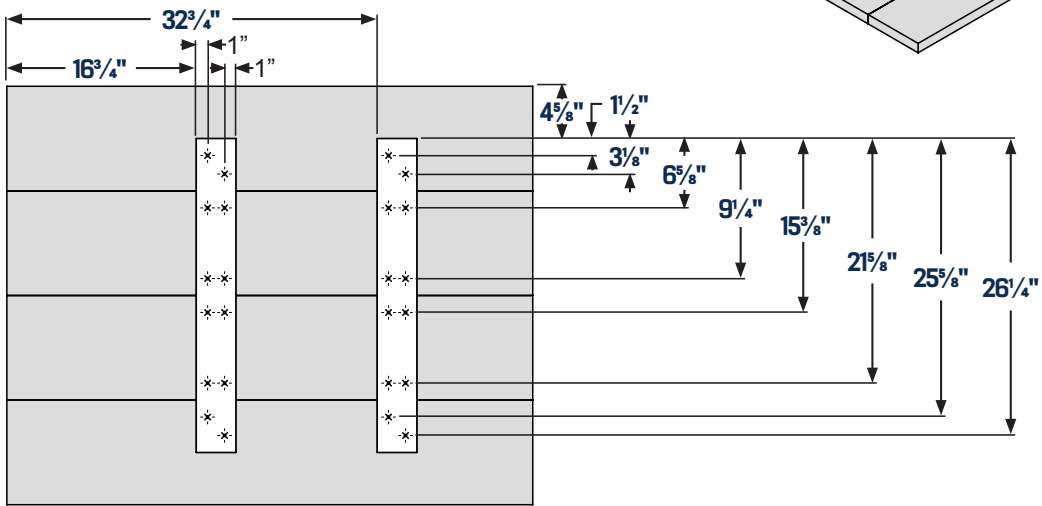
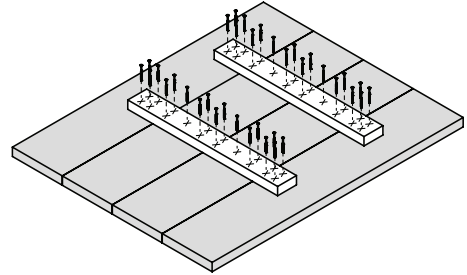

7

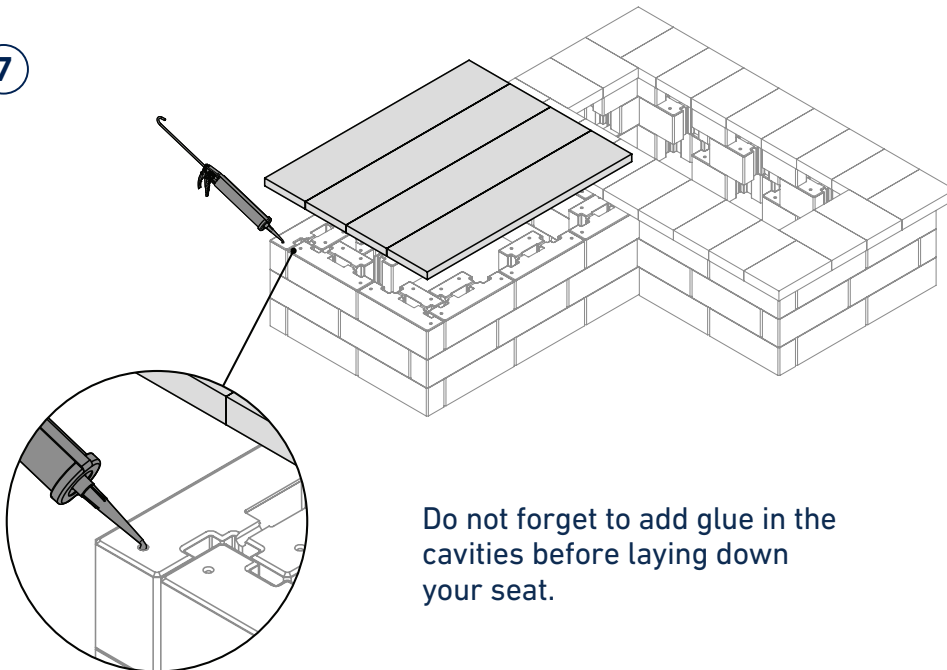

Do not forget to add glue in the cavities before laying down your seat.