



BELGARD®
PAVES THE WAY™

T-BLOCK



68" BENCH

T-BLOCK

COMPLETE THIS STEP
FIRST FOR ALL PROJECTS

BASE PREPARATION

Always level ground before installation

ON NEW OR EXISTING PATIO

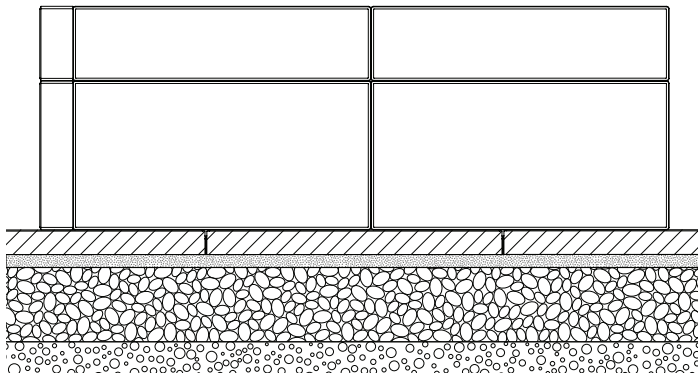

SLAB OR PAVER

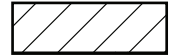

BEDDING SAND 1"

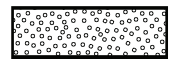

COMPACTED AGGREGATES 6"-8"



SOIL

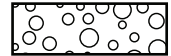

ON POURED CONCRETE

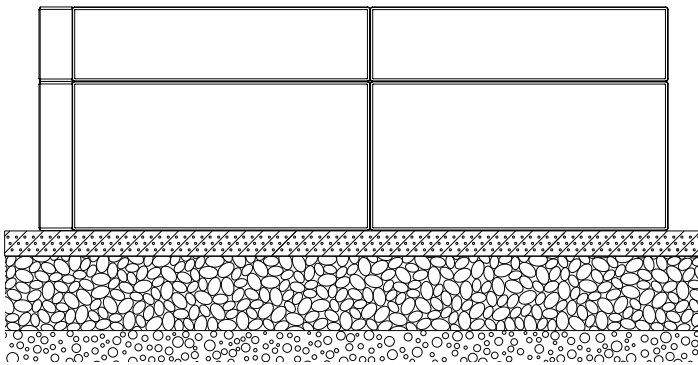

REINFORCED POURED CONCRETE FOUNDATION 2"

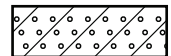

COMPACTED AGGREGATES 6"-8"



SOIL



ON COMPACTED FOUNDATION

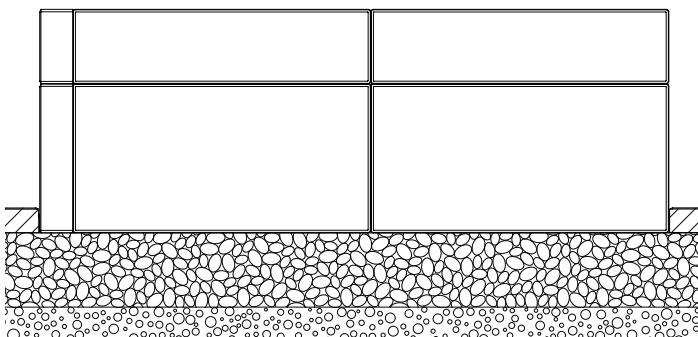

SLAB OR PAVER



COMPACTED AGGREGATES 6"-8"



SOIL

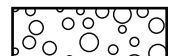

T-BLOCK

68" BENCH

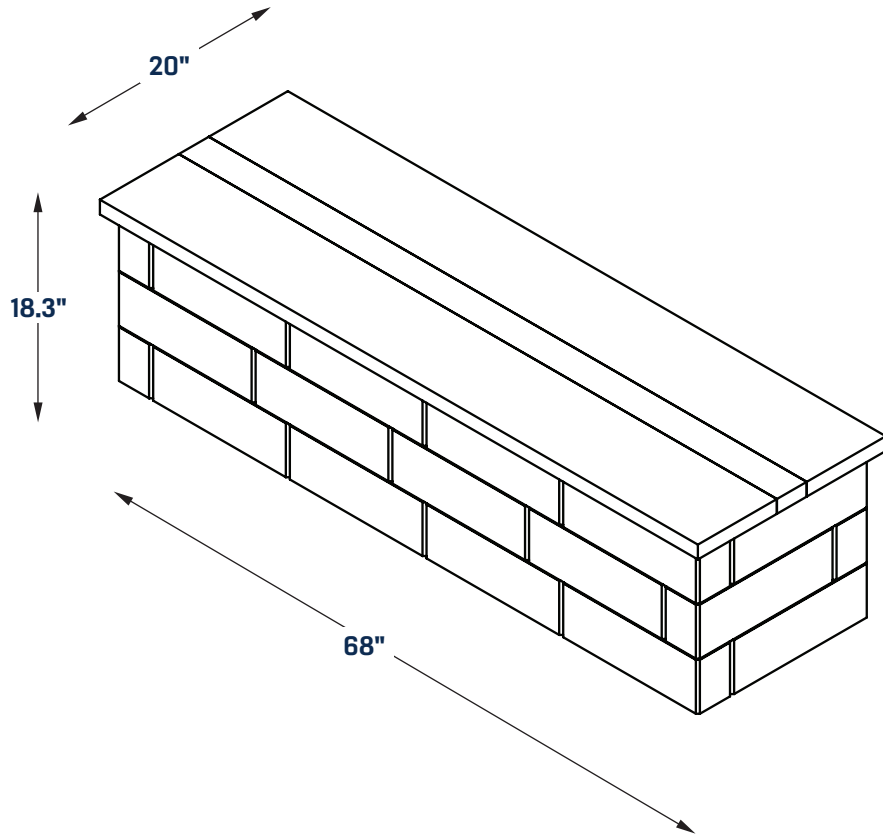

COMPONENTS

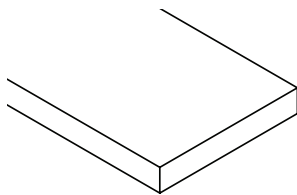

2" x 10" x 8' (x2)

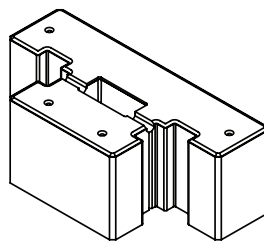

T-Block (x30)



Glue Tube

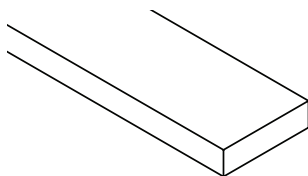

2" x 4" x 8' (x1)



No.8 x 2 1/2" (x12)

T-BLOCK

68" BENCH

REQUIRED TOOLS

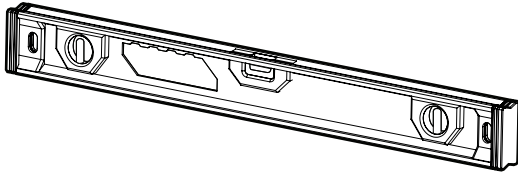

LEVEL

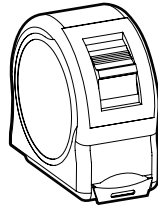

**MEASURING
TAPE**

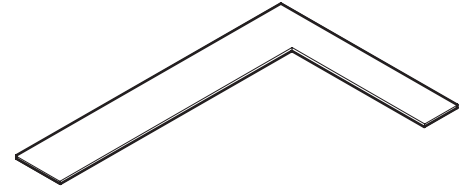

**CARPENTER
SQUARE**

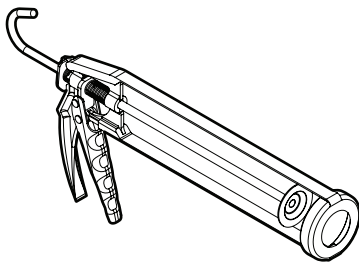

**SILICONE
GUN**

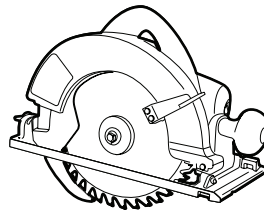

SKILSAW

SAFETY EQUIPMENT



SAFETY BOOTS

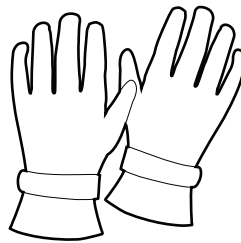

GLOVES

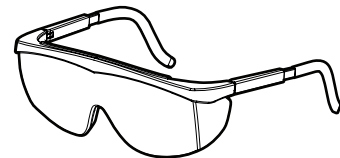

SAFETY GLASSES

T-BLOCK

68" BENCH

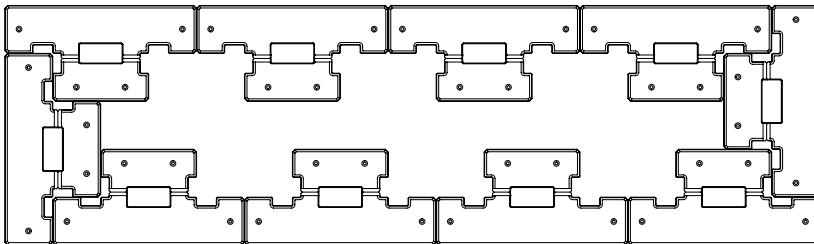
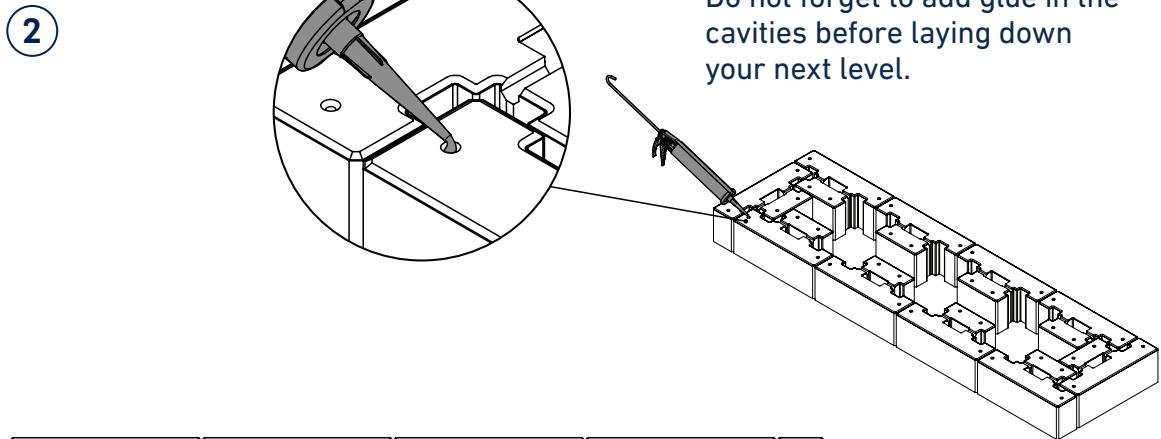
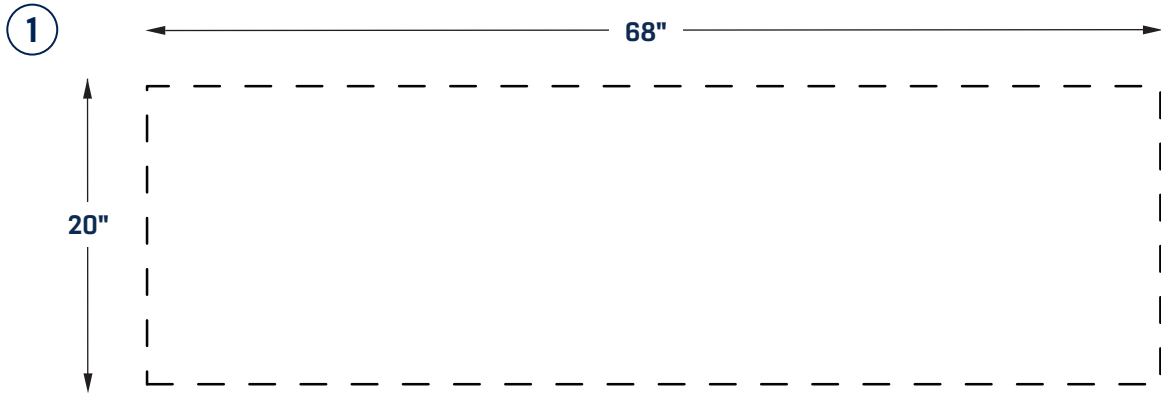

T-BLOCK

68" BENCH

- 3 Do not forget to add glue in the cavities before laying down your next level.

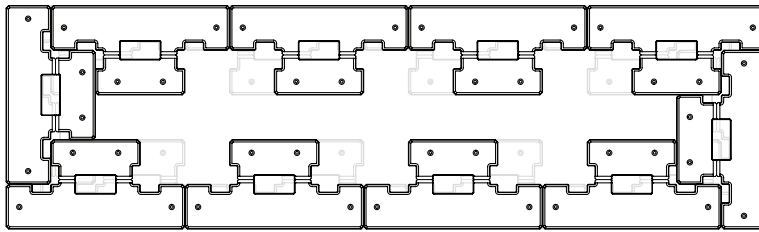
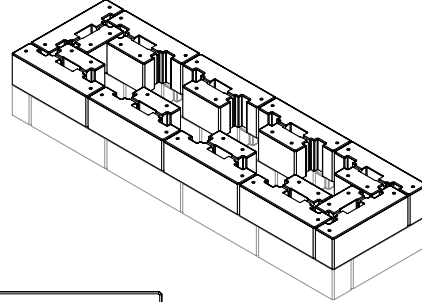

- 4 Do not forget to add glue in the cavities before laying down your next level.

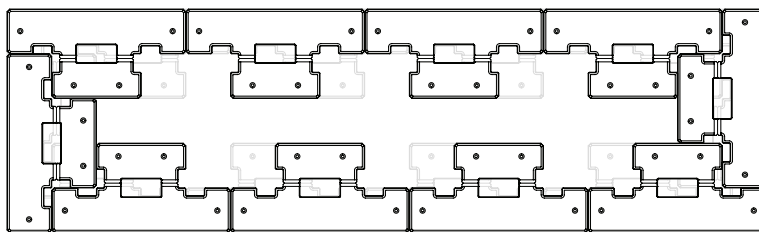
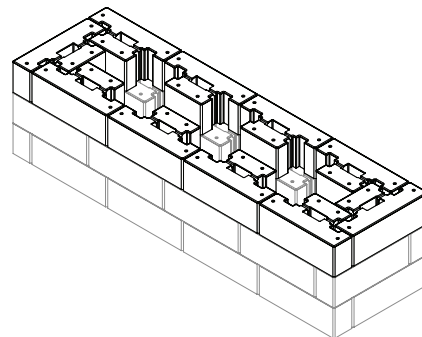

T-BLOCK

68" BENCH

- ⑥ Do not forget to add glue in the cavities before laying down your seat.

