

# METROPOLITAN™ SERIES

METROPOLITAN  
COLLECTION 

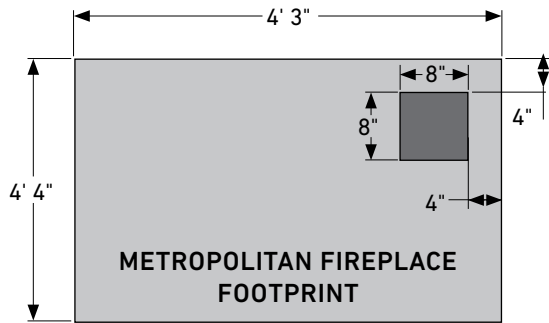

# METROPOLITAN™ SERIES



## FIREPLACE

Rough Dimensions:  
2'7"D x 4'3"W x 7'8"H

Approximate Weight:  
4205 lbs.

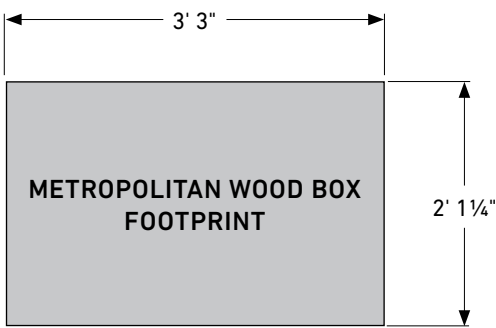
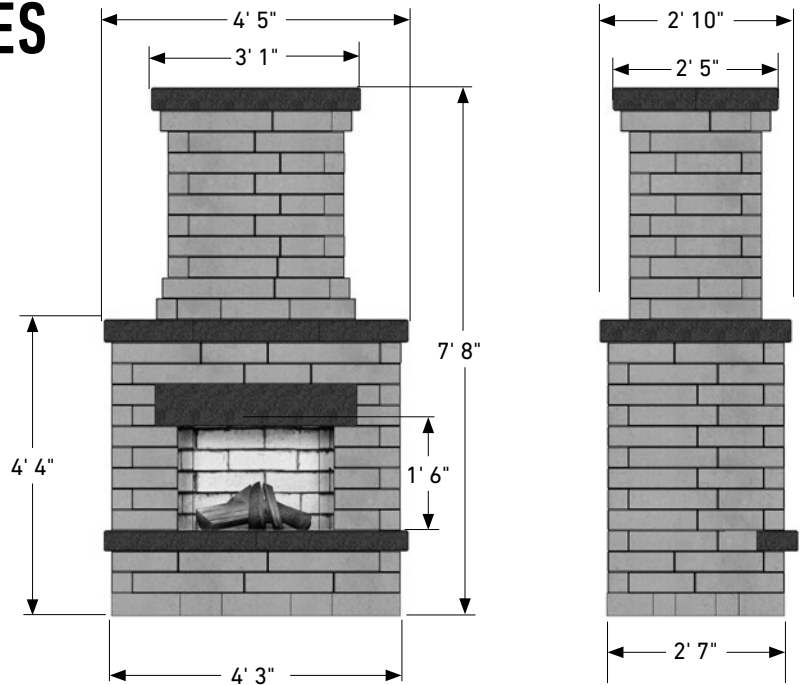

## WOOD BOXES

Rough Dimensions:  
2'1"D x 3'3"W x 3'1"H

Approximate Weight:  
3070 lbs. or 1535 lbs. each

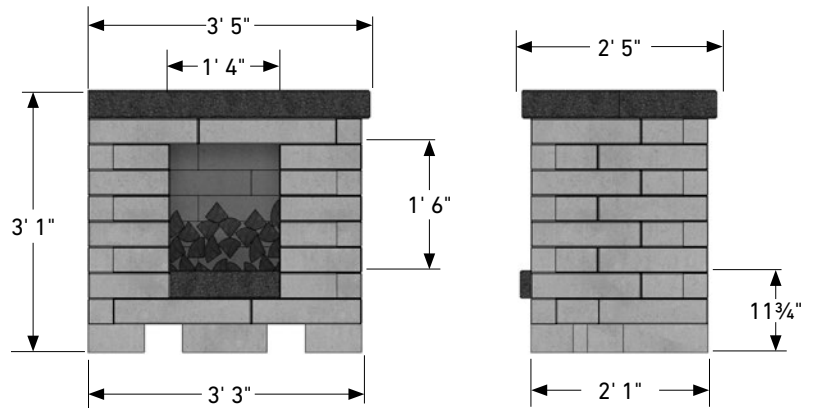

## GRILL ISLAND

Rough Dimensions:  
2'8"D x 5'11"W x 3'5"H

Approximate Weight:  
3500 lbs.

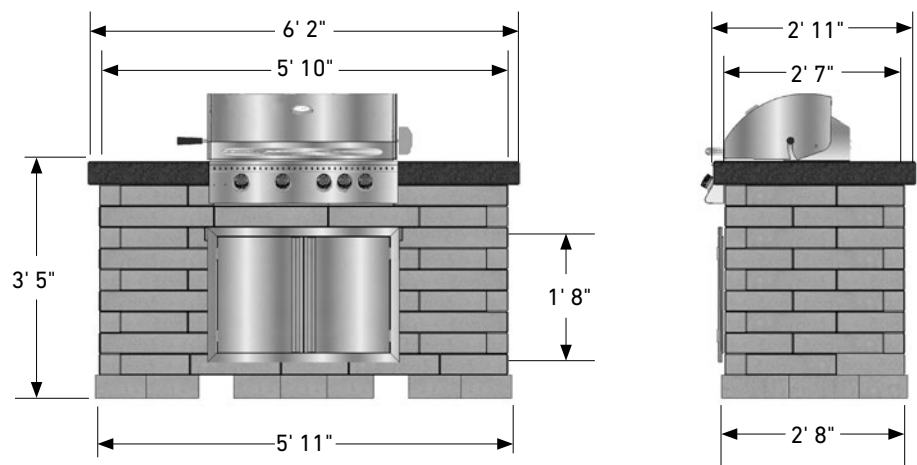

# METROPOLITAN™ SERIES

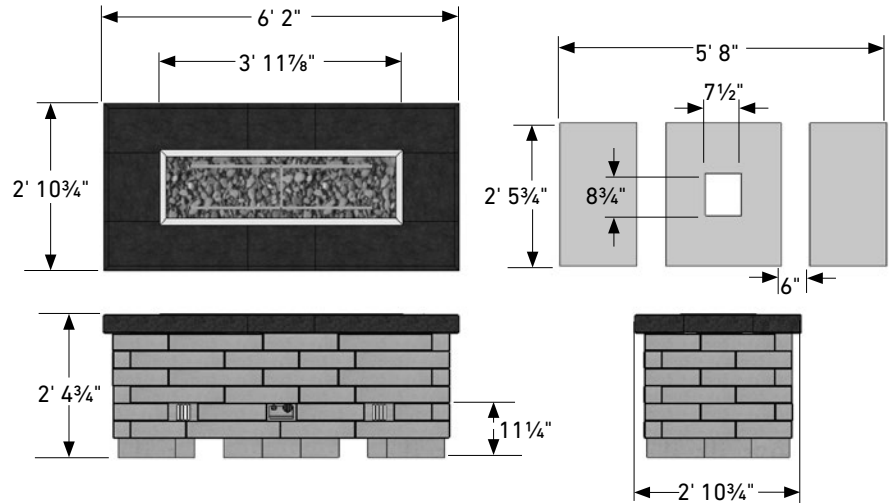

## LINEAR FIRE TABLE

Rough Dimensions:  
2'6"D x 5'8"W x 2'5"H

Approximate Weight:  
2500 lbs.

## LINEAR FIREPLACE

Rough Dimensions:  
2'6"D x 7'1"W x 5' 4"H

Approximate Weight:  
4000 lbs.

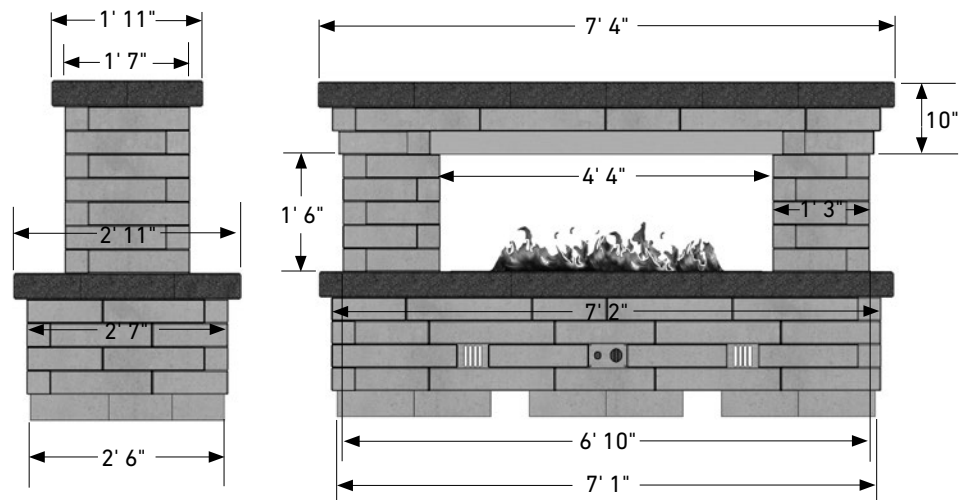

### FIREPLACE

13070020

Metropolitan Wood Fireplace  
Colors: Scandina Gray/Midnight

### WOOD BOXES

13140010

Metropolitan Wood Boxes (Pair)  
Colors: Scandina Gray/Midnight

*36" wood burning fireplace can be converted to a vented gas unit on-site.*

### GRILL ISLAND

13110028

Metropolitan Grill Island  
Colors: Scandina Gray/Midnight

### LINEAR FIREPLACE

13000026

Metropolitan Linear Fireplace  
Colors: Scandina Gray/Midnight

### LINEAR FIRE TABLE

13000027

Metropolitan Linear Fire Table  
Colors: Scandina Gray/Midnight