



BELGARD®
PAVES THE WAY™

T-BLOCK



**WOOD RECTANGULAR
PLANTER**

T-BLOCK

COMPLETE THIS STEP
FIRST FOR ALL PROJECTS

BASE PREPARATION

Always level ground before installation

ON NEW OR EXISTING PATIO

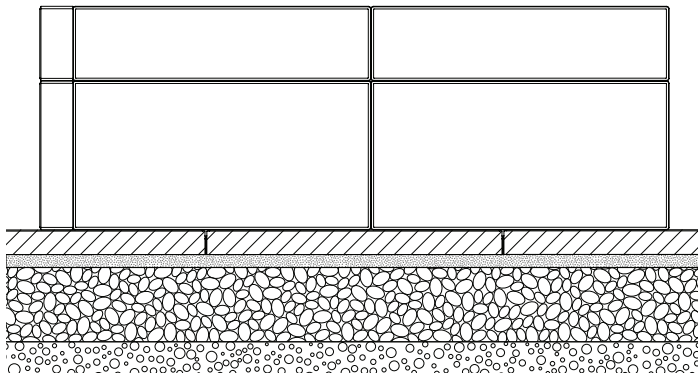

SLAB OR PAVER

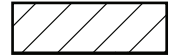

BEDDING SAND 1"

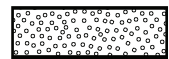

COMPACTED AGGREGATES 6"-8"



SOIL

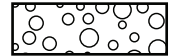

ON POURED CONCRETE

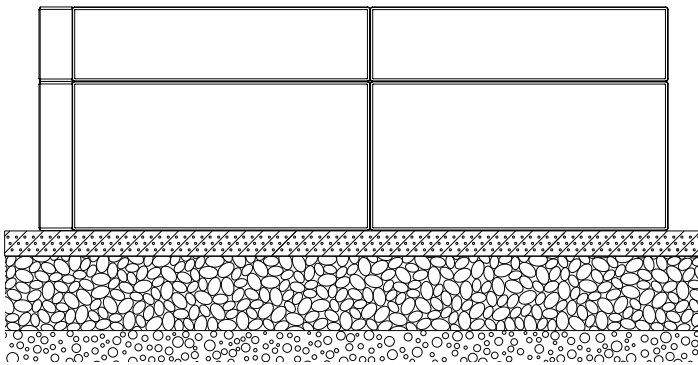

REINFORCED POURED CONCRETE FOUNDATION 2"

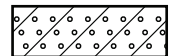

COMPACTED AGGREGATES 6"-8"



SOIL



ON COMPACTED FOUNDATION

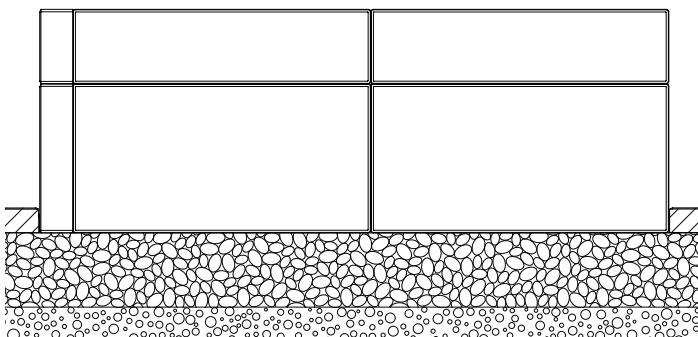

SLAB OR PAVER



COMPACTED AGGREGATES 6"-8"



SOIL

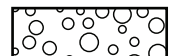



T-BLOCK

WOOD RECTANGULAR
PLANTER

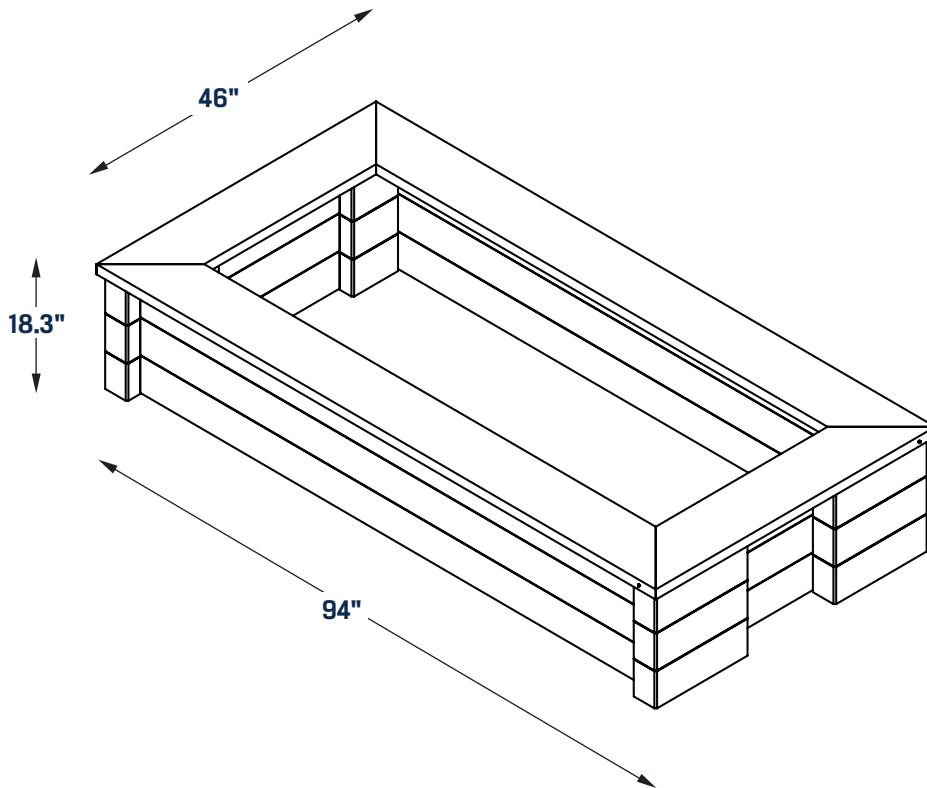

COMPONENTS

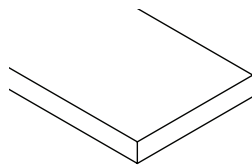

2" x 10" x 8' (x3)

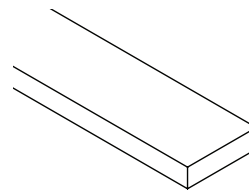

2" x 6" x 8' (x8)

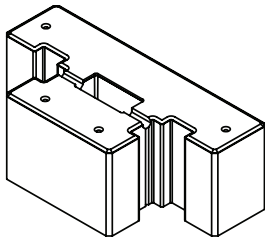

T-Block (x12)



No.8 x 3" (x4)



Glue Tube

T-BLOCK

WOOD RECTANGULAR PLANTER

REQUIRED TOOLS

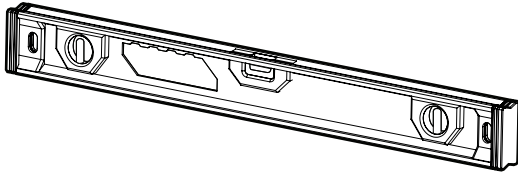

LEVEL

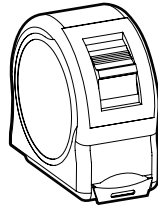

**MEASURING
TAPE**

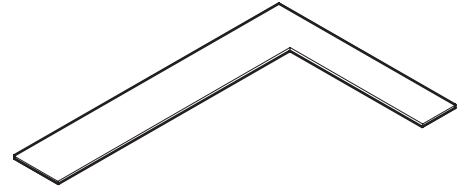

**CARPENTER
SQUARE**

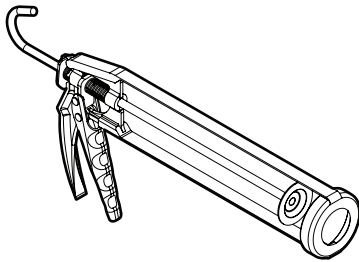

**SILICONE
GUN**

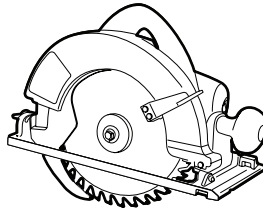

SKILSAW

SAFETY EQUIPMENT



SAFETY BOOTS

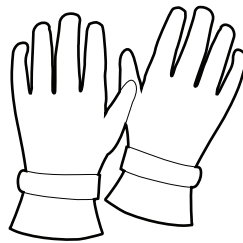

GLOVES

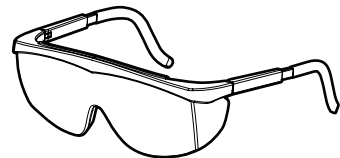

SAFETY GLASSES



T-BLOCK

WOOD RECTANGULAR PLANTER

WOOD CUTS

□ 2" x 6" x 8'

■ 2" x 10" x 8'

A = 23⁷/₈"

B = 87³/₈"

C = 47¹/₂"

D = 95"

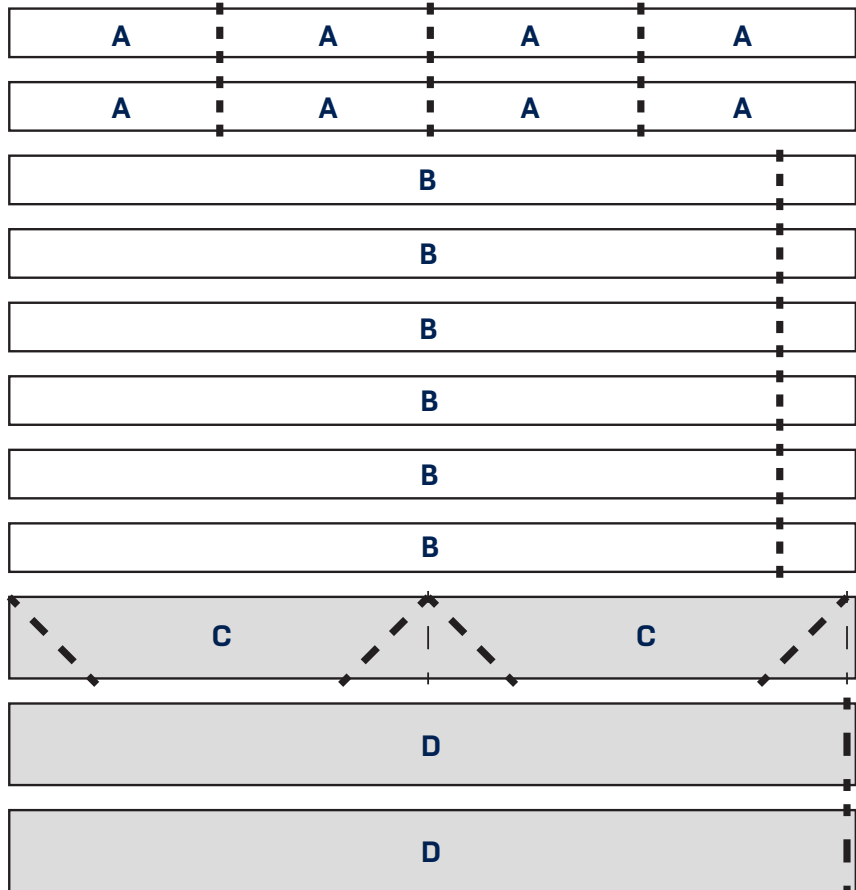
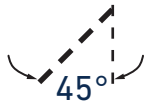

①

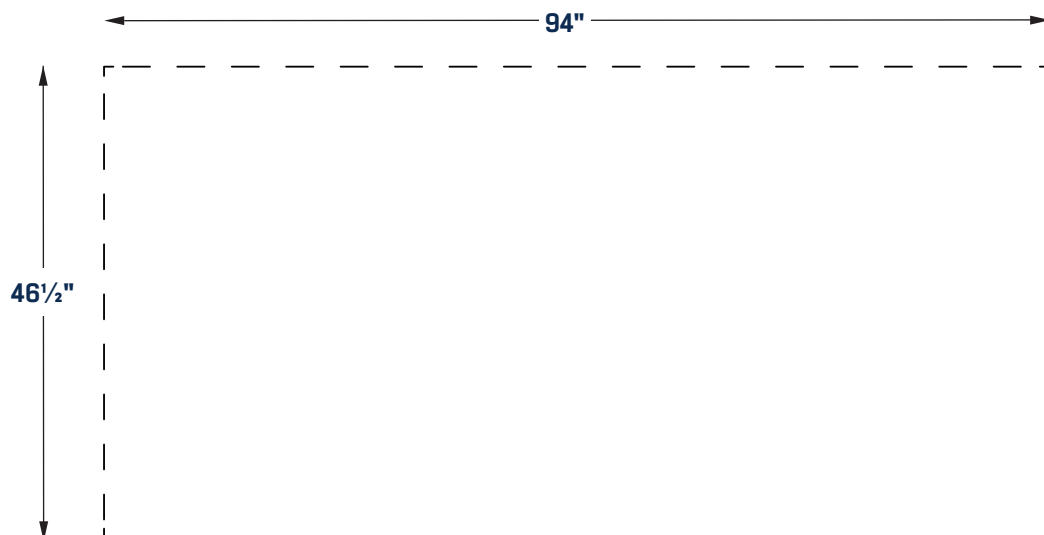



T-BLOCK

WOOD RECTANGULAR PLANTER

2

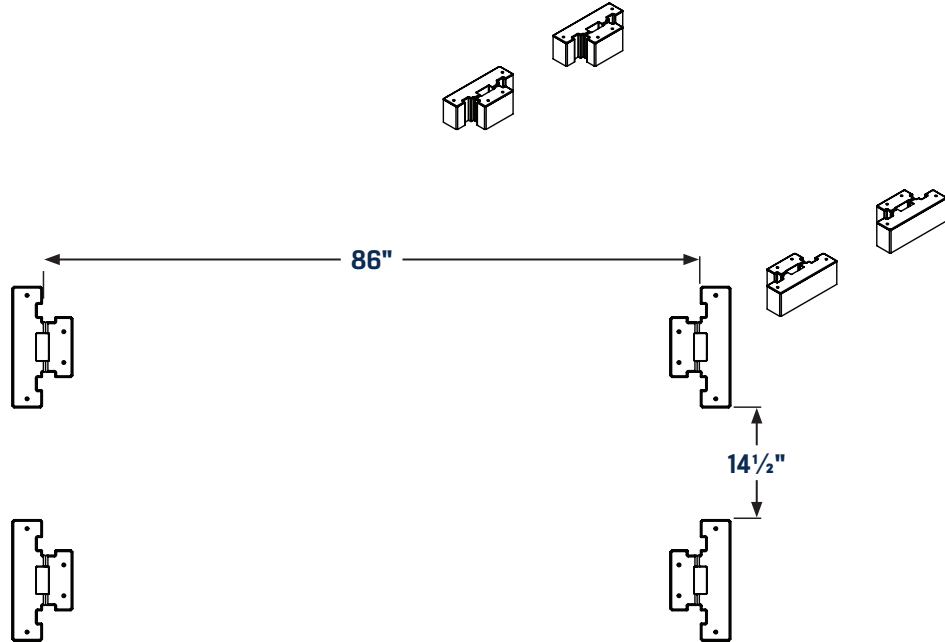

3

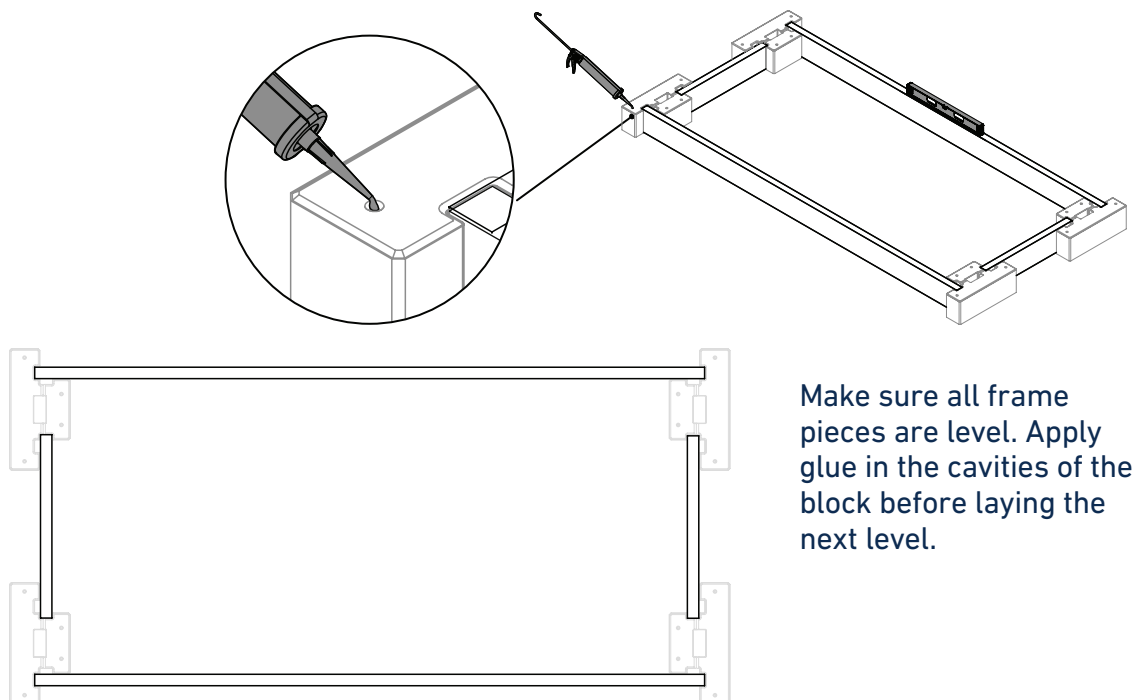



T-BLOCK

WOOD RECTANGULAR PLANTER

- 4 Lay down next level, ensuring they sit flush into place.

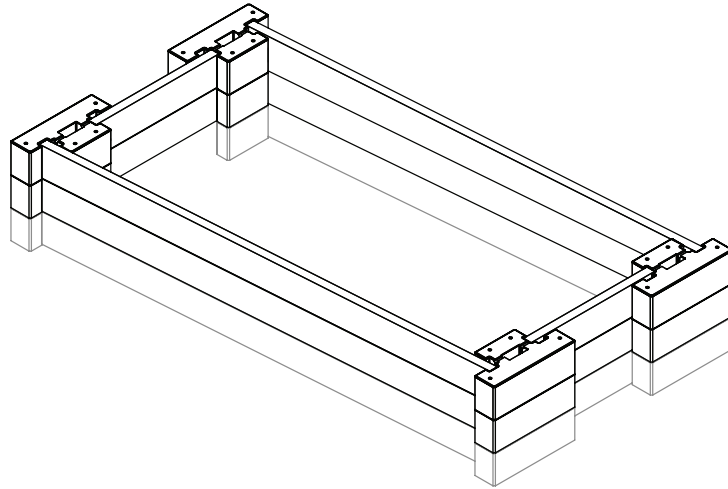

- 5 Put the angle pieces together to create the frame shape, keeping all edges aligned while the glue sets.

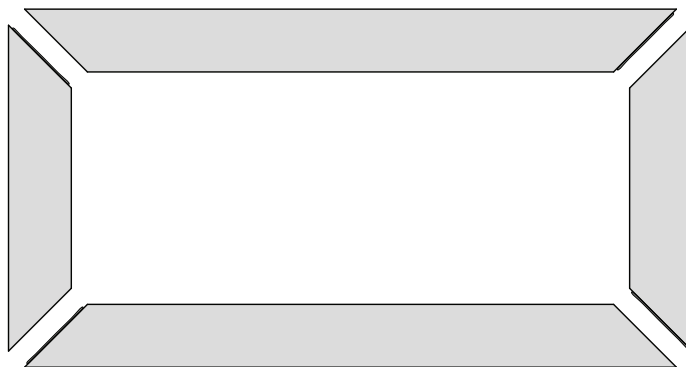
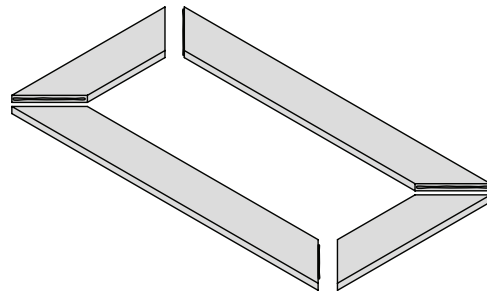

T-BLOCK

WOOD RECTANGULAR PLANTER

- 6 Add the screws in each corner, making sure they go through the middle of the boards for a solid connection.

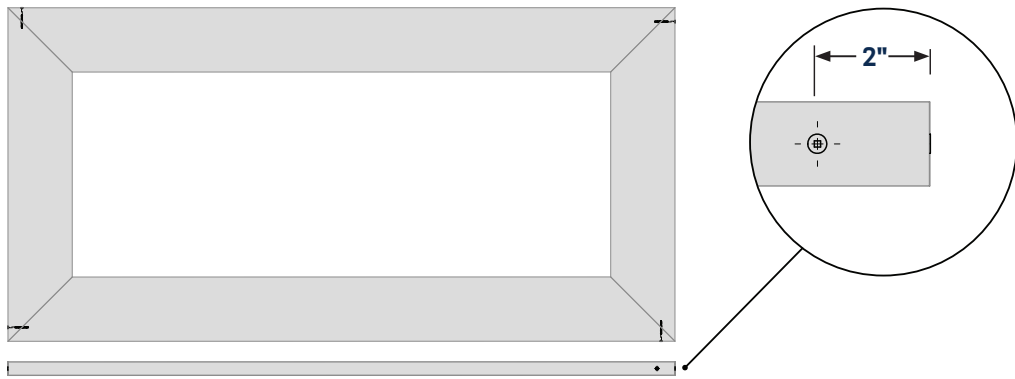

- 7 Apply glue along the top edges of the panels and in the block cavities before setting the frame in place.

