



BELGARD®
PAVES THE WAY™

T-BLOCK



**TWO LOWER PLANTERS
WITH BENCH**

T-BLOCK

COMPLETE THIS STEP
FIRST FOR ALL PROJECTS

BASE PREPARATION

Always level ground before installation

ON NEW OR EXISTING PATIO

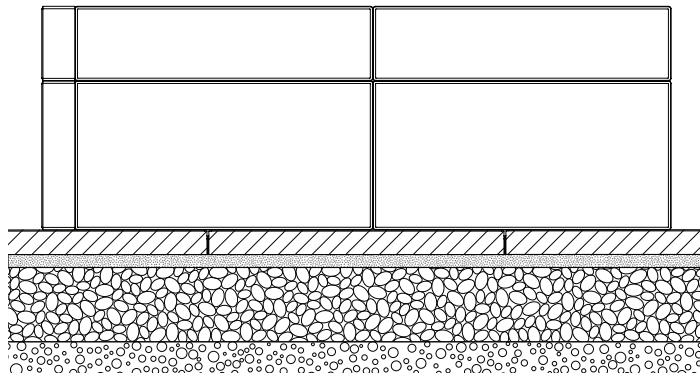

SLAB OR PAVER

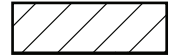

BEDDING SAND 1"

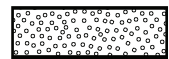

COMPACTED AGGREGATES 6"-8"



SOIL

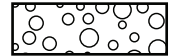

ON POURED CONCRETE

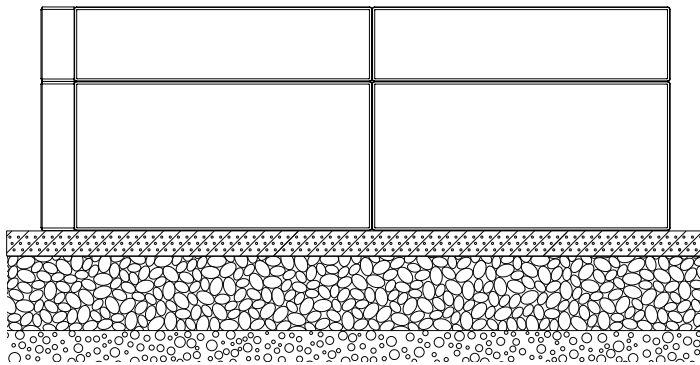

REINFORCED POURED CONCRETE FOUNDATION 2"

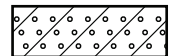

COMPACTED AGGREGATES 6"-8"



SOIL



ON COMPACTED FOUNDATION

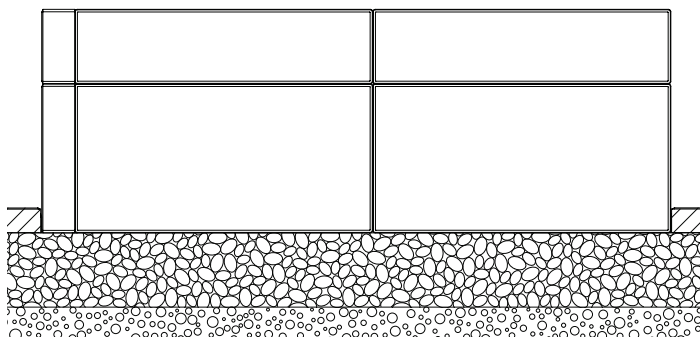

SLAB OR PAVER



COMPACTED AGGREGATES 6"-8"



SOIL

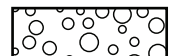



T-BLOCK

TWO LOWER PLANTERS
WITH BENCH

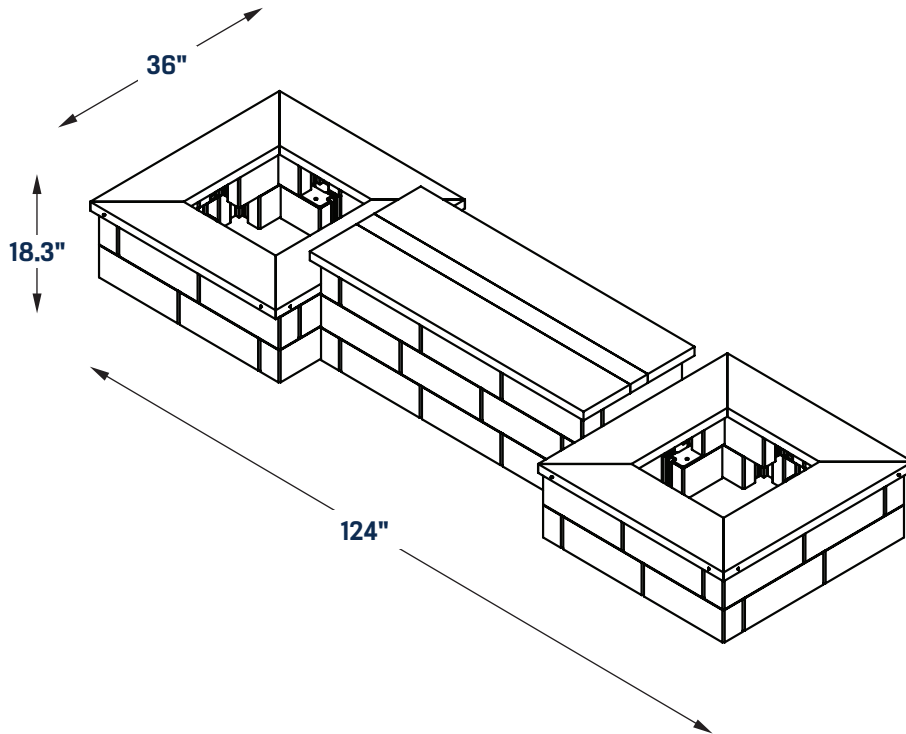

COMPONENTS

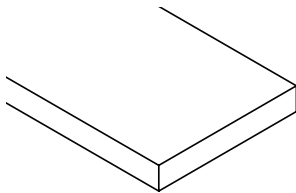

2" x 10" x 8' (x5)

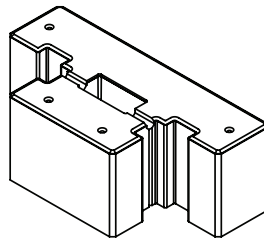

T-Block (x56)



Glue Tube

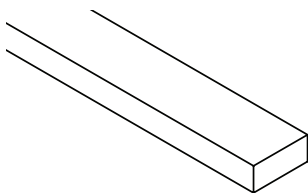

2" x 4" x 8' (x1)



No.8 x 2 1/2" (x12)



No.8 x 3" (x8)



T-BLOCK

TWO LOWER PLANTERS
WITH BENCH

REQUIRED TOOLS

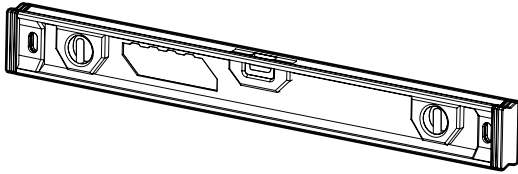

LEVEL

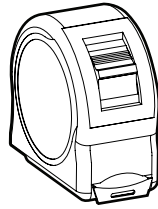

**MEASURING
TAPE**

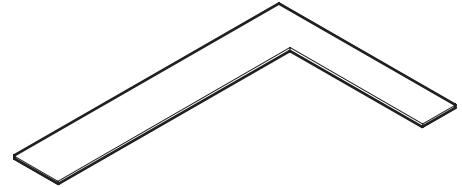

**CARPENTER
SQUARE**

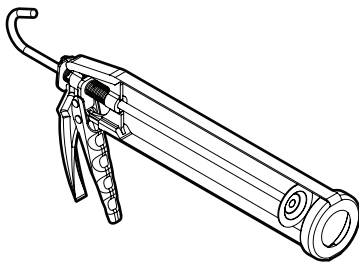

**SILICONE
GUN**

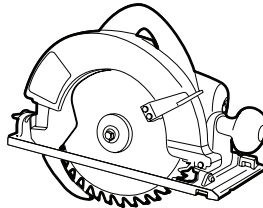

SKILLSAW

SAFETY EQUIPMENT



SAFETY BOOTS

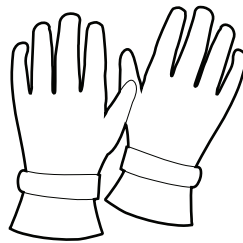

GLOVES

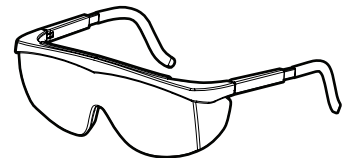

SAFETY GLASSES



T-BLOCK

TWO LOWER PLANTERS WITH BENCH

1

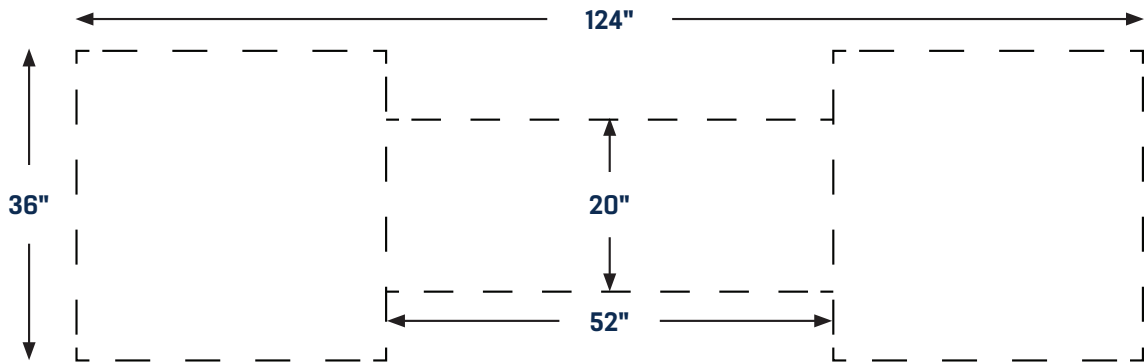

2

Do not forget to add glue in the cavities before laying down your next level.

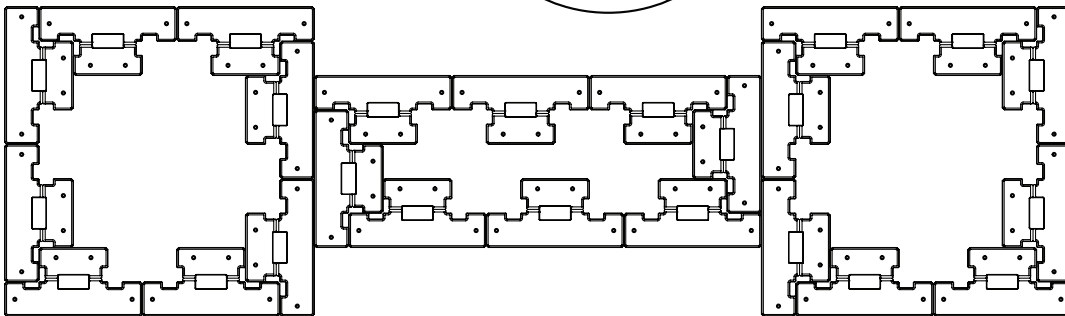
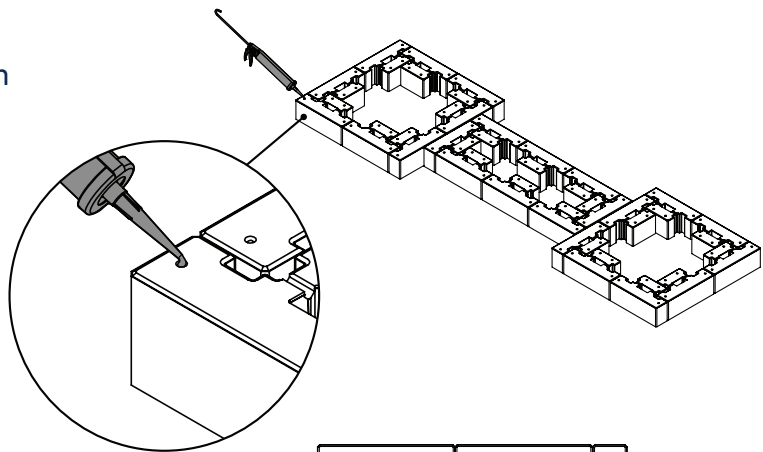



T-BLOCK

TWO LOWER PLANTERS WITH BENCH

3

Do not forget to add glue in the cavities before laying down your next level.

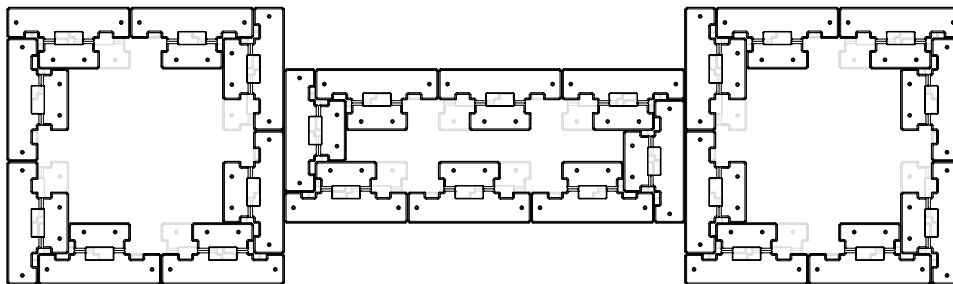
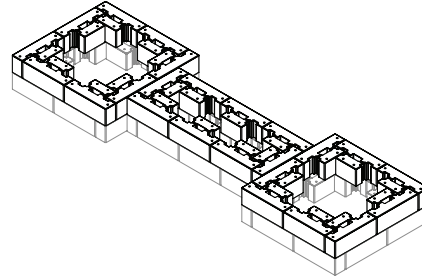

4

Do not forget to add glue in the cavities before laying down your next level.

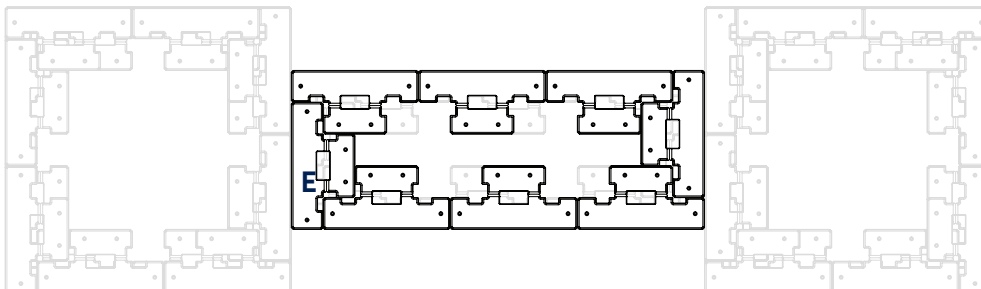
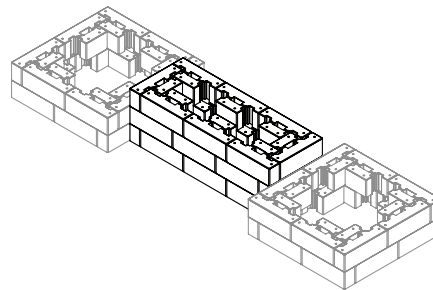



T-BLOCK

TWO LOWER PLANTERS WITH BENCH

WOOD CUTS

□ 2" x 4" x 8'

A = 54"

D = 37 1/4"

■ 2" x 10" x 8'

B = 11 3/4"

E = 36 5/8"

C = 54"

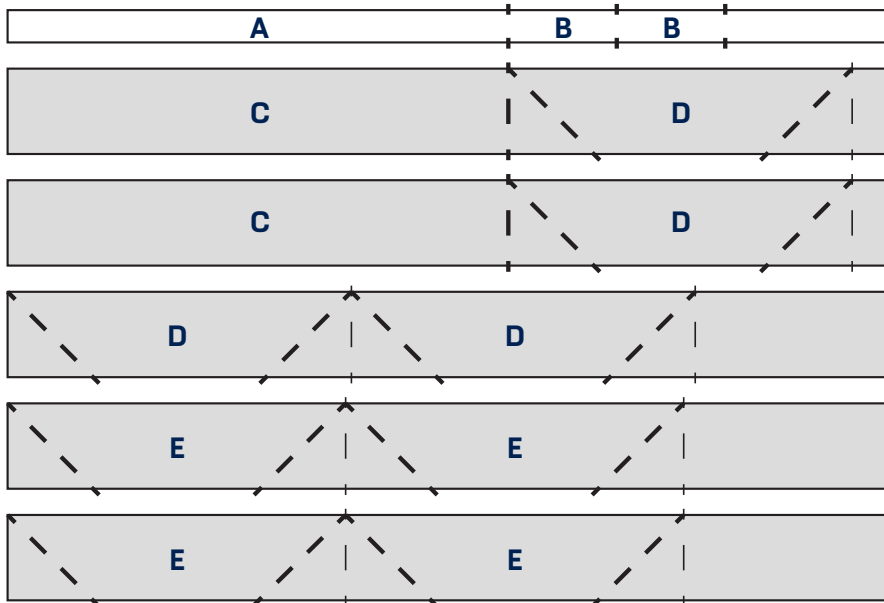
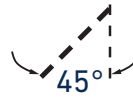

5

Use screws (2 1/4")

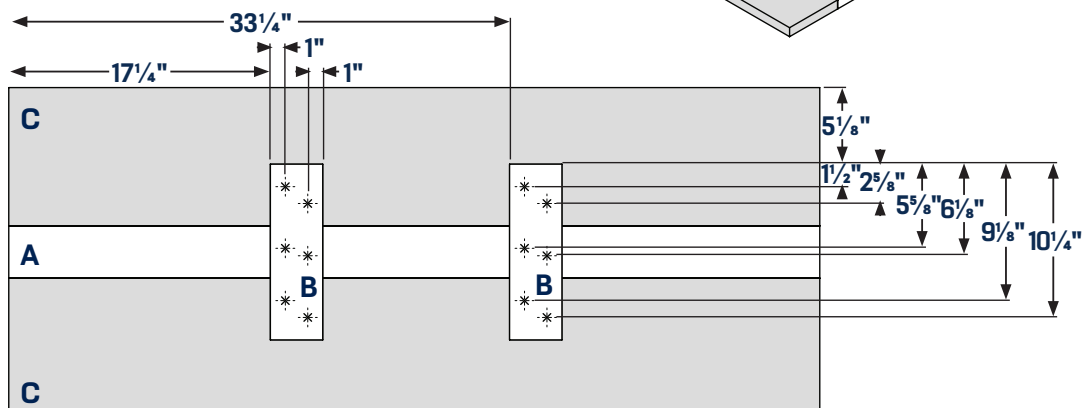
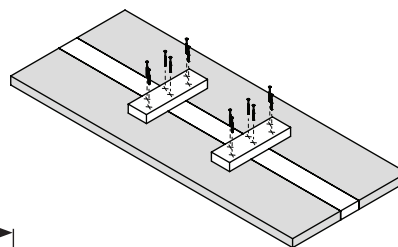



T-BLOCK

TWO LOWER PLANTERS WITH BENCH

6

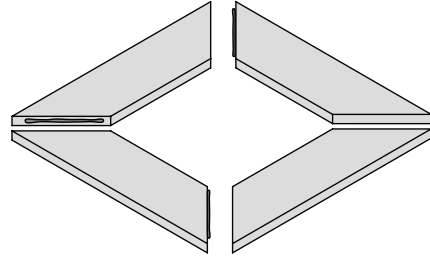
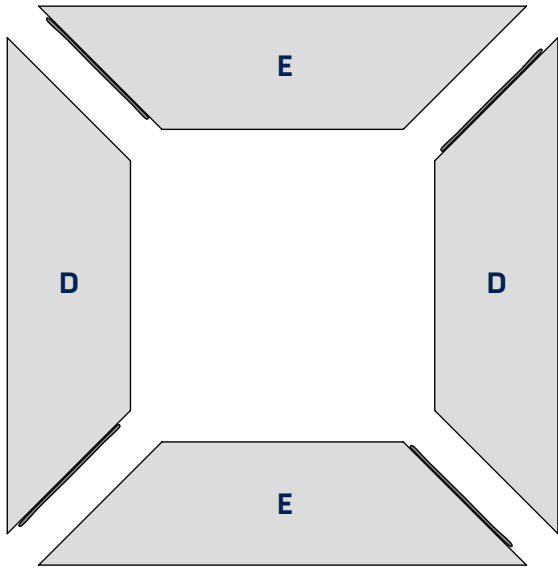

Put the angle pieces together to create the frame shape, keeping all edges aligned while the glue sets. 2X

7

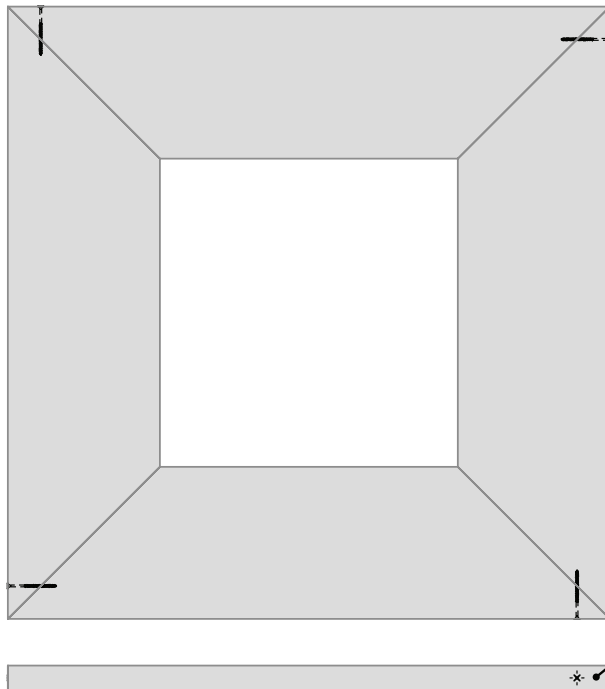

Add the screws (3") in each corner, making sure they go through the middle of the boards for a solid connection. 2X

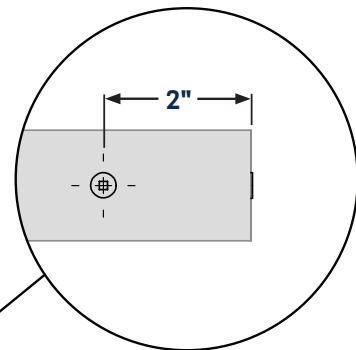



T-BLOCK

TWO LOWER PLANTERS WITH BENCH

- 8 Do not forget to add glue in the cavities before laying down the frame and seat.

