

ARBEL® STONE / MEGA-ARBEL® STONE Pattern

Arbel Stone or Mega-Arbel Stone

Use Arbel Stone or Mega-Arbel Stone.

ARBEL STONE

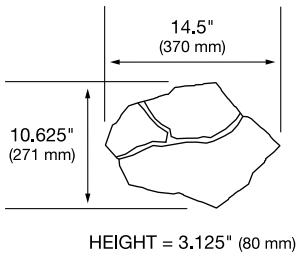

MEGA-ARBEL STONE

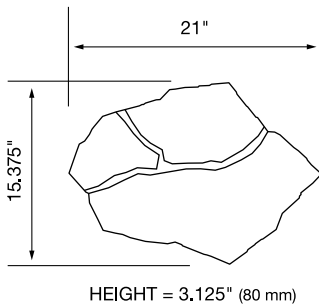

LAYING GUIDE

Before you start, familiarize yourself with Arbel Pavers. Begin by placing 3 pavers together to form a cloverleaf.

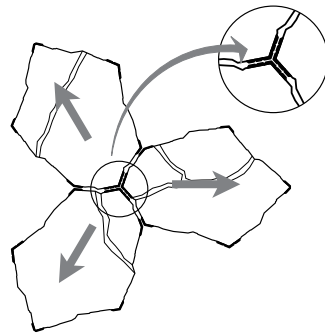

A set of 3 pavers forming a cloverleaf

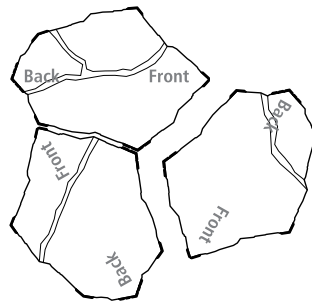

To make the installation easier, the front of the paver should point to the back of the other paver.

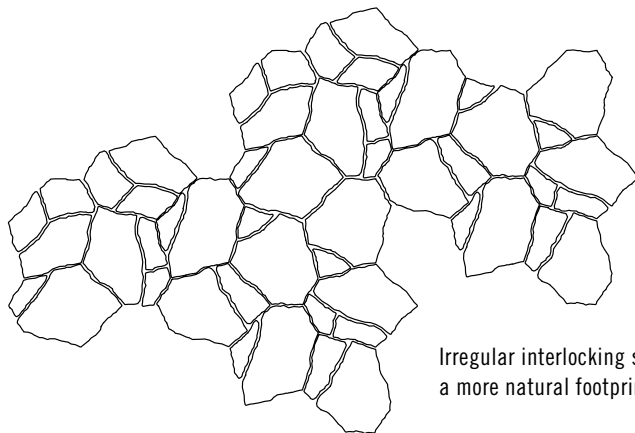

Irregular interlocking system leaves a more natural footprint.

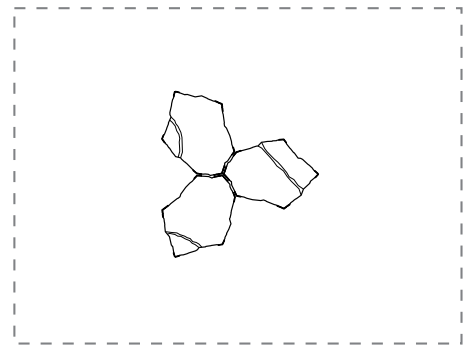

STEP ONE

Begin by laying 3 pavers at the center of the surface to be covered.

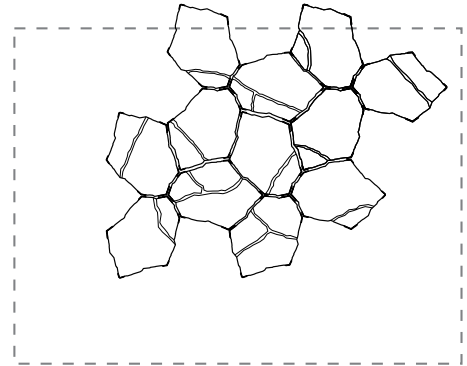

STEP TWO

Add more sets of cloverleaves to fill in the surface to be covered.

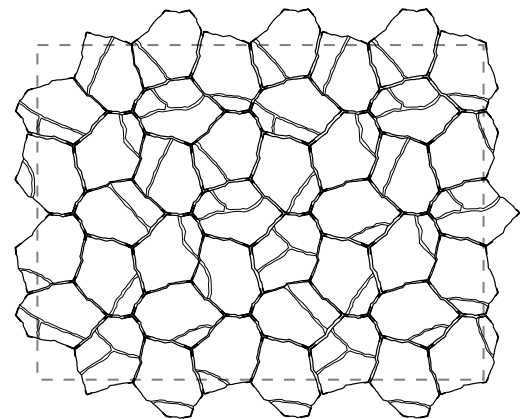

STEP THREE

Complete the balance of the surface to be covered with single pavers.



BE PREPARED FOR COMPANY™